



SIEMENS WEIGHING TECHNOLOGY

Totally integrated weighing

Components and solutions for weighing, dosing and batching
[siemens.com/weighing](https://www.siemens.com/weighing)

SIEMENS

So, what do you need **measured?**

Weighing and dosing processes are of great significance in many areas of industrial production.

Whether for filling food and beverage containers or preparing recipes for chemicals and pharmaceutical products: With our solutions, you can count on absolute reliability and highest precision.



So, what do you need measured?

1

SIWAREX DB – your connection to the digital world

2

SIWAREX weighing modules – available for all requirements

Our SIWAREX weighing electronics at a glance

SIWAREX DB – your connection to the digital world

Load cells and accessories – an overview

Non-automatic weighing

Check weighing

2 Dosing, filling and batching applications **12**

Loss-in-weight applications **13**

Belt scales **14**

Product overview **15**

8 Solids flowmeters **16**

Weighfeeder **17**

Integrators – stand-alone **18**

Integrators – SIMATIC-integrated **19**

6 Process protection **20**

3

8 **Sales and support** **21**

9 Siemens weighing trainings – on-site and online **22**

11

Seamless **integrated weighing** technology in the SIMATIC environment

1 SIMATIC PLC

The free standard example projects and function blocks offer full access to all parameter and data of the weighing electronics and allow a fast integration of the scales into existing automation programs and visualizations. In case of alarms, integrated hardware interrupts provide full transparency from the sensor to the controller. Following SIMATIC standards, a long term availability of all electronics and components is guaranteed.

Based on a continuous handling concept across all different weighing electronics, a quick and easy integration of new types of scales is ensured.

2 Userfriendly HMI

The HMI panel offers completely editable user interfaces. All relevant workflow processes, such as operating, monitoring and maintenance can be done directly from the central HMI, means there is no struggle with any additional black box on the machine.

Besides that, the HMI offers a customer-friendly error handling: due to the detailed error message system, the errors will be shown in a clear text which leaves no questions unanswered. You need more than one language to be displayed? No problem, foreign languages can easily be added via simple EXCEL ex- and import. But the HMI does not only offer comfort regarding the handling during daily business.

The SIMATIC Comfort HMI, for instance can also be used as legal-for-trade main display.

3 Continuous hardware concept

The hardware concept considers the SIMATIC standards, which makes the wiring easy and guarantees a clear structure in the cabinet.

By using SIMATIC standard controllers and I/O cards, you will achieve highest flexibility and scalability in your weighing environment. Besides that you can decide whether to install your components centrally or as distributed system.

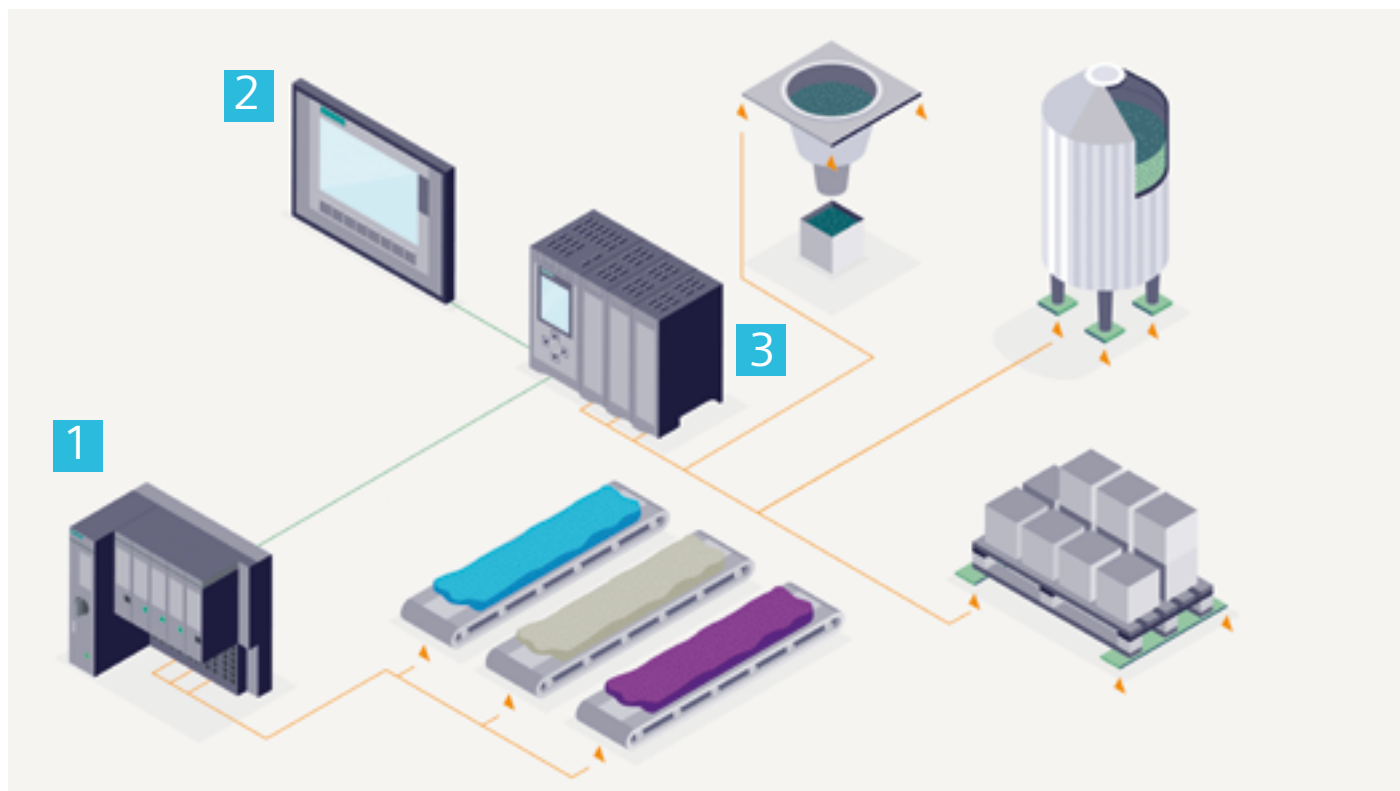



Whether you need to produce accurate mixtures, ensure precise filling and loading, or perform tasks like legal-for-trade bagging, checking and dosing: SIWAREX WP351 is always the right choice. It's the perfect fit for all automatic and non-automatic weighing applications.



SIWAREX weighing modules – available for all requirements

Whether central or distributed: our electronic weighing systems set standards. We offer integrated solutions for seamless integration into the SIMATIC automation system under the name SIWAREX. The weighing system can be easily adapted to meet your individual requirements with the SIMATIC standard components. Moreover, standardized interfaces, integrated functions, and uniform tools allow for cost-effective configuration. Whatever your choice, you can count on a high degree of precision with SIWAREX and benefit from certifications according to OIML as well as a finely graded range of functions.

Our **SIWAREX** weighing electronics at a glance



	SIWAREX WP351	SIWAREX WP231	SIWAREX WP241	SIWAREX WP251
Article No.	7MH4138-6BA00-0CU0	7MH4960-2AA01	7MH4960-4AA01	7MH4960-6AA01
Type	High feature automatic weighing module for dosing, batching, filling, totalizing and checking scale applications within SIMATIC ET 200SP	Non-automatic scale applications like fill level monitoring of silos, hopper scales, platform and crane scales within SIMATIC S7-1200 systems or stand-alone operation	Conveyor belt scale applications within SIMATIC S7-1200 systems or stand-alone operation. Control of weighfeeder applications can be easily realized via PID loop in S7-1200 PLC	Automatic weighing module for dosing, batching, filling, totalizing and checking scale applications within SIMATIC S7-1200 systems or stand-alone operation
Key features	<ul style="list-style-type: none"> • Only 20 mm module width • Seamless integration into SIMATIC ET 200SP • 1 000 Hz sampling rate und processing time • Certified according to OIML R-51, R-61, R-76 and R-107 	<ul style="list-style-type: none"> • Resolution of up to \pm four million parts • Four digital in- and outputs, one analog output on board • Certified according to OIML R-76 • Certified according to NTEP 	<ul style="list-style-type: none"> • Resolution of up to \pm four million parts • Four digital in- and outputs, one analog output on board 	<ul style="list-style-type: none"> • Resolution of up to \pm four million parts • Four digital in- and outputs, one analog output on board
	SIWAREX WP321	SIWAREX WP521 ST/ SIWAREX WP522 ST	SIWAREX WT231	SIWAREX WT241
Article No.	7MH4138-6AA00-0BA0	7MH4980-1AA01 7MH4980-2AA01	7MH4965-2AA01	7MH4965-4AA01
Type	Technology module for the distributed I/O system SIMATIC ET 200SP. Suitable for non-automatic scales in level measurement in silos and bunkers and platform scales	Technology modules for the SIMATIC S7-1500 advanced controller family Optimally prepared for gravimetric level measurement of silos and hoppers as well as for platform scales	Weighing terminal for platform scales, silo and bunker weighing, scales in hazardous areas, force measurement Weighing terminal for conveyor belt scale applications	Weighing terminal for conveyor belt scale applications
Key features	<ul style="list-style-type: none"> • Resolution of up to \pm two million parts • Compact design • "Ready for use" sample application • Scale internal control of freely definable limit values 	<ul style="list-style-type: none"> • Resolution of up to \pm four million parts • Integrated part of TIA portal • Automatic impedance control of the load cells, process, and diagnostic alarms 	<ul style="list-style-type: none"> • Resolution of up to \pm four million parts • RS485 Modbus RTU • 4 digital inputs (floating) • 4 digital outputs (floating) • 1 analog output (0/4...20 mA) 	<ul style="list-style-type: none"> • Resolution of up to \pm four million parts • RS485 Modbus RTU • 4 digital inputs (floating) • 4 digital outputs (floating) • 1 analog output (0/4...20 mA)



Whether it's the specific monitoring of weighing processes or extended diagnostics – in environments that have already been automated, the benefits of digitalization can be exploited to ever better effect.

In the field of weight measurement, seamless integration from the field to the control levels ensures that data is recorded and evaluated more comprehensively than previously possible. With SIWAREX DB, this level of connectivity now also covers the individual analog load cell.



SIWAREX DB – your connection to the digital world

Analogue limitations are left behind with SIWAREX DB. Instead of doing a parallel connection of the analog load cells and having no information about the single load cell, digitalization of each load cell offers full transparency.

SIWAREX DB makes the digitalization of the proven, most common and cost-effective strain gauge technology possible. For direct connection to a SIMATIC S7 or PCS7 PLC the SIWAREX WP weighing electronics are ideal.

Seamless communication between SIWAREX and SIMATIC ensures less time and effort during commissioning. During operation the single channel monitoring, allowing wire break, impedance, and the current utilization of each load cell to be detected and corrected in the event of an error.

SIWAREX DB supplies diagnostics data that are fully integrated in the SIMATIC environment. Error messages are displayed centrally on the SIMATIC controller and the HMI.

Load cells and accessories – an overview



SIWAREX load cells							
	SIWAREX WL230 BB	SIWAREX WL230 SB	SIWAREX WL250	SIWAREX WL260	SIWAREX WL270	SIWAREX WL280	SIWAREX WL290
Article No.	7MH5106-...	7MH5121-... 7MH5107-...	7MH5105-...	7MH5102/03/04/ 16/17/18/20/23	7MH5108/10/14-...	7MH5113-...	7MH5122-...
Type	Bending beam for platform and hopper scales	Shear beam load cell for platform and hopper scales, overhead track scales	S-type load cell for tension and pressure applications, hanging and hopper scales, hybrid scales	Single point load cell for platform scales	Compression load cell for hopper scales, overhead truck scales, vehicle scales	Ring torsion load cell for platform and hopper scales, conveyor belt scales, roller table scales	Double shear beam load cell for big platform, hopper, and vehicle scales
Key features	<ul style="list-style-type: none"> Rated load from 10 kg to 500 kg C3 to OIML R60 IP68 	<ul style="list-style-type: none"> Rated load from 0.1 to 10 t C3, C4, C5 to OIML R60 IP67 	<ul style="list-style-type: none"> Rated load from 50 kg to 10 t C3 to OIML R60 IP67 	<ul style="list-style-type: none"> Rated load from 0.3 kg to 200 kg C3, C4MR to OIML R60 IP66, IP67, IP68, IP69K 	<ul style="list-style-type: none"> Rated load from 2.8 t to 500 t C3 to OIML R60 IP66/IP68 	<ul style="list-style-type: none"> Rated load from 60 kg to 60 t C3 to OIML R60 IP66/IP68 	<ul style="list-style-type: none"> Rated load from 2.3 t to 113 t C3 to OIML R60 IP67
...and the mounting units and junction boxes							
	SIWAREX WL230 SB	SIWAREX WL230 BB	SIWAREX WL270	SIWAREX WL290	SIWAREX WL280 RN	SIWAREX DB	SIWAREX JB
Article No.	7MH5721-... 7MH5707-...	7MH4133-...	7MH5708-... 7MH5710-... additional lines 7MH3115-... 7MH5714-...	7MH5722-...	7MH4130-... 7MH4125-... 7MH4115-... additional line 7MH5713-...	7MH5001-0AD-...	7MH5001-0AA-...
Type	Compact mounting unit, base plate, elastomer bearing and load foot platform and hopper scales, roller table scales	Compact mounting unit, elastomer bearing for platform and hopper scales, roller table scales	Compact mounting unit for hopper scales	Mounting unit for platform and hopper scales and onboard weighing	Compact installation unit and arm, Elastomer bearings for platform and hopper scales, roller table scales	Digital junction box 4 channels for connection cells	Junction and extension boxes to connect several load cells to one SIWAREX weighing system
Key features	<ul style="list-style-type: none"> Rated load from 10 kg to 500 kg, 0.5 t to 5 t Material: stainless steel, nickel-plated steel and neoprene 	<ul style="list-style-type: none"> Rated load from 10 kg to 500 kg Material: stainless steel and neoprene 	<ul style="list-style-type: none"> Rated load from 2 t to 50 t, 100 t Material: stainless steel 	<ul style="list-style-type: none"> Rated load from 2.3 kg to 113 t Material: nickel-plated steel 	<ul style="list-style-type: none"> Rated load from 60 kg to 60 t Material: stainless steel and neoprene 	<ul style="list-style-type: none"> Material housing aluminum or stainless steel IP66 	<ul style="list-style-type: none"> Material: aluminium or stainless steel IP66

Non-automatic weighing

High scalability

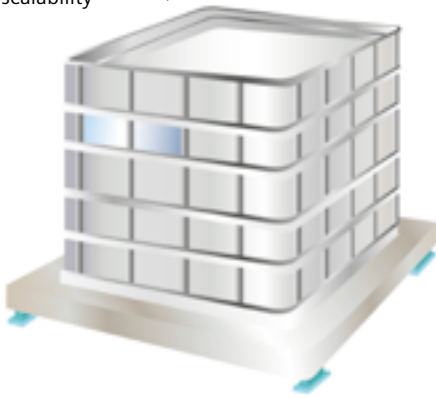

Easy and seamless integration of all SIWAREX weighing modules into the SIMATIC environment – TIA Portal or PCS7

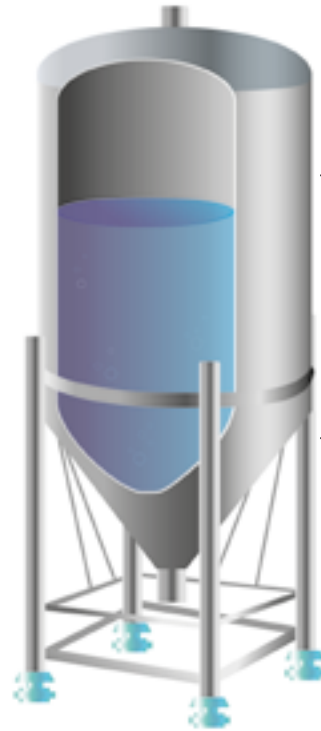

Legal-for-trade according OIML R-76

The corresponding SIWAREX electronics provide extensive features and functions to fulfill all requirements of non-automatic scale applications

Non-automatic weighing

Platform scales: possible loads – a truck, a bin, a bucket or raw materia.

Hopper scales: for liquids, powders, solids and gases.

Detection of precise levels of stored materials.

The optimal choice

SIWAREX WP231 (SIMATIC S7-1200/stand-alone)

SIWAREX WP321 (SIMATIC ET 200SP)

SIWAREX WP521/522 ST (S7-1500/ET 200MP)

SIWAREX WT231 (stand-alone)

SIWAREX DB digital junction box

SIWAREX load cells and installation accessories



Weighing air cargo shipments reliably



Cargologic AG is a leader in air cargo handling and has been operating at Zurich Airport for more than 50 years. To weigh individual freight units and complete unit load devices (ULDs), a floor model of a platform scale is used. The solution was a combination comprised of four SIWAREX WL280 RN-S SA load cells and the SIWAREX WP231 weighing module.

Check weighing

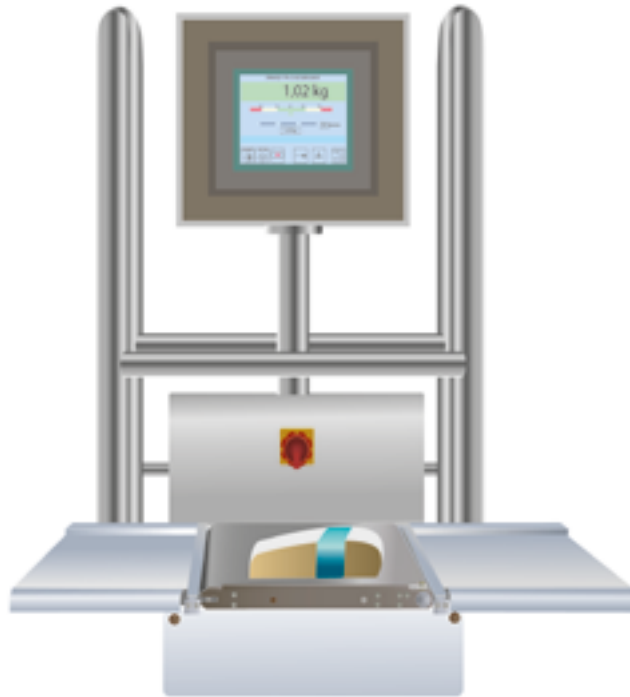

Dosing, batching and bagging scale

A predefined set-point is completely automatically batched by the SIWAREX electronic – typically by coarse and fine flow control.

Dosing, batching and high-speed bagging (bagging machines, multi component batching)

The optimal choice

SIWAREX WP351 (SIMATIC ET 200SP)
 SIWAREX WP251 (SIMATIC S7-1200/stand-alone)
 SIWAREX FTA (SIMATIC S7-300/400/ET 200M)
 SIWAREX load cells and installation accessories



Exact weighing for fruit and vegetable packaging



The end customer of the plant builder RMA techniek was not able to conduct final check weighing at the end of the packaging process. A custom weighing solution in an integrated control environment had to change all that. The core element of the solution is the SIWAREX S7-1215C controller.

Dosing, filling and batching applications



On board I/O signals guarantee highest possible reaction times and therefore accuracy

Intelligent algorithms for automatic optimizing of the dosing results

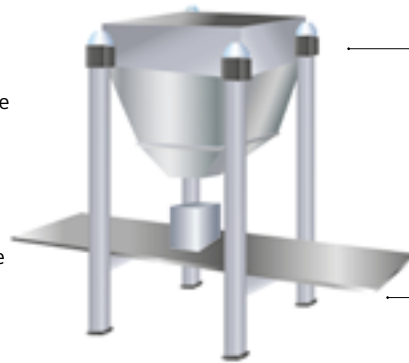

Legal-for-trade according OIML R-51, R-61, R-76, R-107

In combination with SIMATIC controllers, all requirements and additional functions can be easily realized

Dosing, batching and bagging scale

A predefined set-point is completely automatically batched by the SIWAREX electronic – typically by coarse and fine flow control.

Dosing, batching and high-speed bagging (bagging machines, multi component batching)

The optimal choice

SIWAREX WP351 (SIMATIC ET 200SP)
SIWAREX WP251 (SIMATIC S7-1200/stand-alone)
SIWAREX load cells and installation accessories
SIWAREX DB



Accurate weighing at smallest place



Gima SpA, Bologna, Italy, specializes in automated packaging solutions for tea, coffee, beverages, foods such as dairy and convenience products. A new machine for filling coffee capsules shall be projected and put in operation.

Loss-in-weight applications

Very competitive for retrofit of old systems

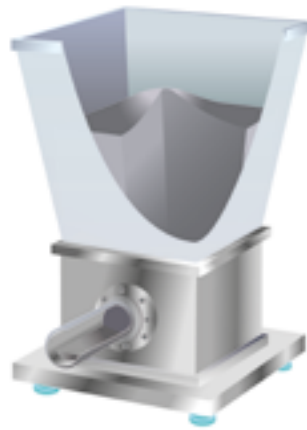

Complex tasks easily solved with SIWAREX and SIMATIC

The only loss-in-weight system fully integrated in SIMATIC format

Loss-in-weight scales

A loss-in-weight feeder regulates the mass flow rate (quantity per time).

A loss-in-weight system helps to achieve the needed level of accuracy in continuous dosing applications.

Feeding extruders and adding additives into continuous processes

The optimal choice

SIWAREX FTC (SIMATIC S7-300/400/ET 200M)
SIWAREX load cells and installation accessories



Filling processes in washing powder production



Mifa AG is Switzerland's largest detergent and cooking oil manufacturer and also produces detergents and household-cleaning products in liquid and powder form. A solution with Siemens weighing products has been found for the company's outdated washing powder filling system that has done more than just positively affect productivity.

Belt scales

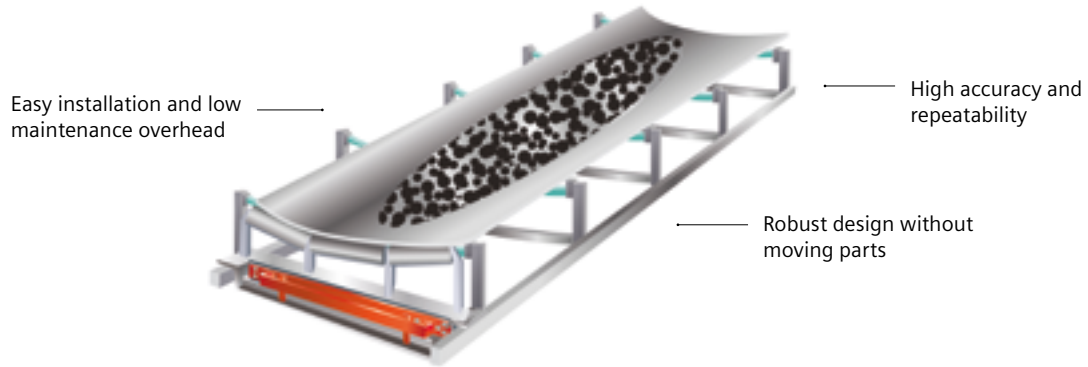

High performance for all industries

Weighing and controlling the rate of materials on a conveyor belt is one of the most common procedures in process automation. Siemens has more than 35 years of experience weighing bulk materials on conveyors. You will find our reliable equipment in almost any industry.

Milltronics belt scales from Siemens combine simple drop-in installation and low maintenance (no moving parts) with repeatable high accuracy for productive operation. With various hazardous and trade approvals, Milltronics belt scales can be used in almost any industrial environment or application.



Accurate measuring for a Russian phosphate mine



Apatit Mining in Russia is the world's largest producer of high grade phosphate ore which is used as a raw material base for the production of phosphate-based fertilizers. The company was looking to modernize and expand production and needed an accurate and reliable system to weigh the ore to determine the mine's production rates. The picture shows MSI belt scale with MWL calibration system.

Product overview



	Milltronics MMI	Milltronics MSI	Milltronics MLC	Milltronics WD600	Milltronics MUS	Milltronics MCS
Article No.	7MH7122	7MH7122	7MH7126	7MH7185	7MH7123	7MH7125
Type	High accuracy and demanding applications		Chemical, recycling, and food applications with light loading		Modular belt scales for general purpose non-critical applications	
Key features	<ul style="list-style-type: none"> • ±0.25% accuracy over a 5:1 rate range (MMI-2) • ±0.125% accuracy over a 5:1 rate range (MMI-3) • Industry leading performance 	<ul style="list-style-type: none"> • ±0.5% accuracy over a 5:1 rate range • Triple beam load cells 	<ul style="list-style-type: none"> • ±0.5 to 1% accuracy over a 4:1 rate range • Precision idler for maximum resolution • Triple beam load cells 	<ul style="list-style-type: none"> • ±0.5 to 1% accuracy over a 4:1 rate range • Compact load cell design 	<ul style="list-style-type: none"> • ±0.5 to 1% accuracy over a 4:1 rate range • Modular design • Standard and heavy duty option 	<ul style="list-style-type: none"> • ±0.5 to 1% accuracy over a 4:1 rate range • Triple beam load cells for optimum performance • Low profile for easy conveyor integration

	Milltronics MWL weight lifter	Milltronics test chains	Milltronics TASS	Milltronics RBSS	SITRANS WS300	Bend pulleys
Article No.	7MH7218	7MH7161	7MH7131	7MH7134	7MH7177	7MH7170/1, 7MH7187/8
Type	Belt scale calibration devices		Wheel driven speed sensors for return belt mounting		Shaft driven speed sensor for tail or bend pulley	Frame mounted bend pulley to take WS300 speed sensor
Key features	<ul style="list-style-type: none"> • Calibration weight lifter for use with belt scales. MWL safely applies and stores calibration test weights for belt loading simulation. • Secured test weights for reliable verification • Safety lock for storage during conveying 	<ul style="list-style-type: none"> • Calibration test chains for dynamic belt loading simulation for Milltronics belt scales. • Precision machined for optimum accuracy over calibration • Dynamic loading simulation • High test loading 	<ul style="list-style-type: none"> • Compact low profile design 	<ul style="list-style-type: none"> • Heavy duty design and wheel assembly for harsh conditions • Protected sensor and targets from falling debris • High resolution speed sensing 	<ul style="list-style-type: none"> • Compact, rugged design for shaft mounting • Low to high resolution options • Aluminum and stainless steel construction options 	<ul style="list-style-type: none"> • Pre-drilled mounting for SITRANS WS300 speed sensor • Creates installation room for belt scale

Solids flowmeters

Flowguide sizes to fit any ASME or DIN flange

Measuring accuracy is not affected by product buildup on the sensing plate



— Dust-tight enclosure to prevent contamination or spilling

— Quick-release latches for maintenance and sampling

	SITRANS WF100	SITRANS WF200	SITRANS WF330	SITRANS WF340	SITRANS WF250	SITRANS WF350
Article No.	7MH7186	7MH7115	7MH7102	7MH7104	7MH7115	7MH7106
Type	Load cell based compact design	Load cell based for higher flowrates	LVDT based versatile	LVDT based low height	Air slide applications	
Key features	<ul style="list-style-type: none"> Capacity up to 90 m³/h Dust-tight enclosure 	<ul style="list-style-type: none"> Capacity up to 500 m³/h Dust-tight enclosure Large particle sizes 	<ul style="list-style-type: none"> Capacity up to 290 m³/h Dust-tight enclosure High temp materials 	<ul style="list-style-type: none"> Capacity up to 230 m³/h Dust-tight enclosure High temp materials 	<ul style="list-style-type: none"> Capacity up to 600 m³/h Dust-tight enclosure Unique solution 	<ul style="list-style-type: none"> Capacity up to 550 m³/h Dust-tight enclosure Unique solution



Solids flowmeters in a fertilizer plant

In a fertilizer plant, crushed dolomite and crushed limestone are mixed in a reactor, whereby the mixing ratio of 1:3 must be maintained. The materials are conveyed from silos via screw conveyors into the solids flowmeters and brought together in a bucket elevator for conveying into the reactor. The exact mixing ratio is ensured by the speed of the screw conveyors, which is controlled by a PLC, on the basis of the respective throughput rates of the solids flowmeters.

Weighfeeder

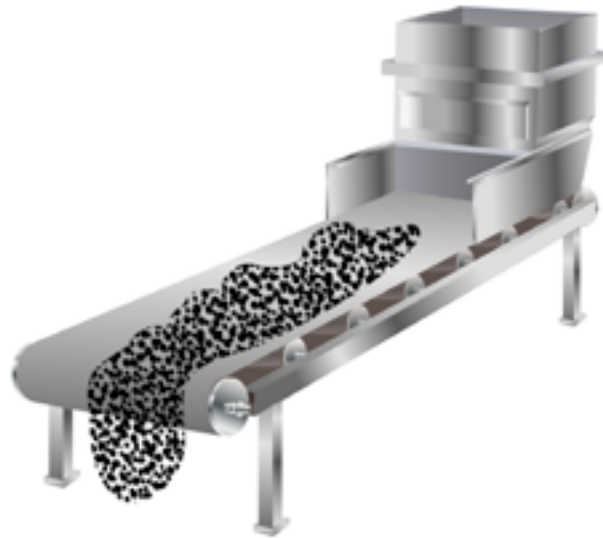

	SITRANS WW100	SITRANS WW200
Article No.	7MH7180	7MH730x
Type	Compact style	Various design options
Key features	<ul style="list-style-type: none"> • High accuracy for low flowrates • Capacity up to 30 m³/h • CL inlet to discharge only 838 mm • Large range due to Servodrive • Short delivery time 	<ul style="list-style-type: none"> • Designed for food industry • Easy cleaning due to slider bars for belt transport • Capacity up to 120 m³/h • Up to 1200 mm belt width • Various options and designs available



Reliable pleasure thanks to Siemens weighing technology



The cigar manufacturer J. Cortès has two production sites in Belgium and about 3600 employees around the world. At its site in Handzame, the company was looking for a fail-proof weighing system to maintain the necessary balance in terms of flavor. Based in Torhout, the industrial weighing expert Bascules Robbe therefore turned to Siemens. Together, they offered a complete and customized solution.

Integrators – stand-alone

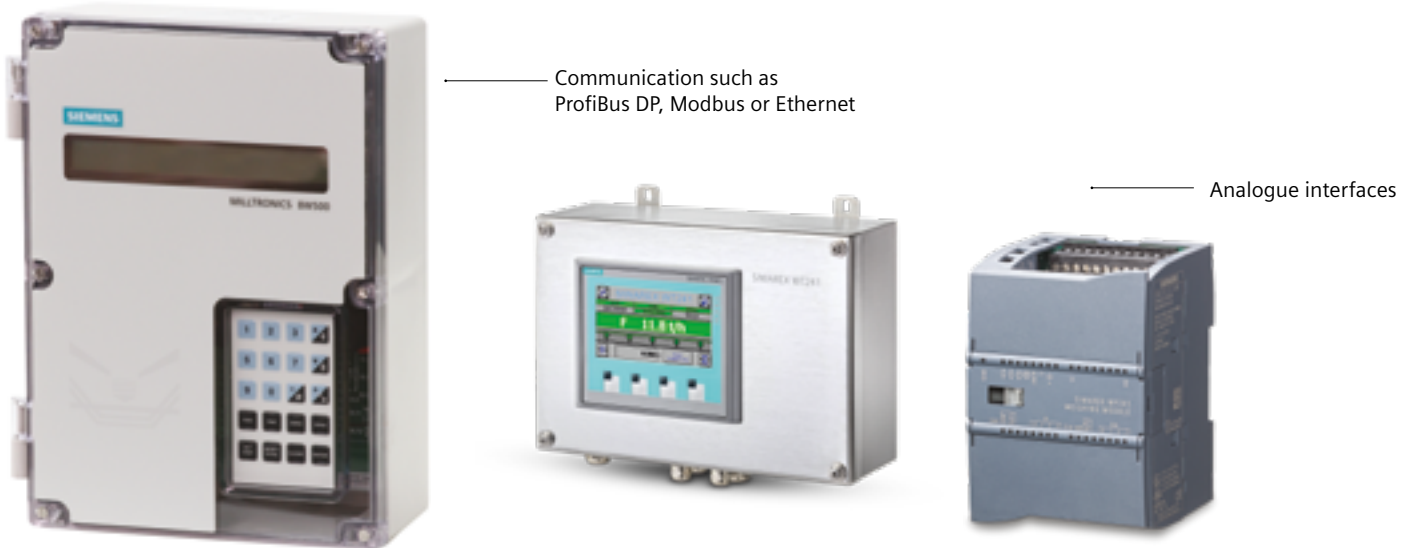

Stand-alone integrators

Our integrators display primary speed and load values, as well as derived values of rates as analog mA output, alarm relay, or remote totalizer or through several industrial communications protocols.

	Milltronics BW500 /BW500L	Milltronics SF500	SIWAREX WP241	SIWAREX WT241
Article No.	7MH7152	7MH7156	7MH4960-4AA01	7MH4965-4AA01
Type	Full feature belt scale and weighfeeder applications	Full solids flowmeter applications	Belt scales	Weighing terminal for conveyor belt scale applications
Key features	<ul style="list-style-type: none"> • 7 different languages supported • 7 different industrial communications available • 2 analog inputs, 3 analog outputs • PID control and batching functions • 5 programmable relays 	<ul style="list-style-type: none"> • 7 different languages supported • 7 different industrial communications available • 5 programmable relays • Multispan calibration 	<ul style="list-style-type: none"> • Can be used stand-alone • Resolution of one million digits • Simulation mode for belt load and/or belt speed • Usable in hazardous applications • ATEX zone 2 	<ul style="list-style-type: none"> • Resolution of up to ± four million parts • RS485 Modbus RTU • 4 digital inputs (floating) • 4 digital outputs (floating) • 1 analog output (0/4...20 mA)

Integrators – SIMATIC-integrated

Belt scale modules for S7-300, S7- and via ET200M to S7-400 or PCS7-1200

Analogue interfaces like stand-alone



SIMATIC-integrated integrators

Beltscale electronics for seamless integration into the SIMATIC S7-1200 automation system. Flowrate, belt speed, load and status info are easily adapted into PLC system. Parametrization and calibration can be done by PLC, HMI or SIWATOOL software for Notebooks.

	SIWAREX WP241
Article No.	7MH4960-4AA01
Type	Belt scales
Key features	<ul style="list-style-type: none"> • Can be used stand-alone • Resolution of one million digits • Simulation mode for belt load and/or belt speed • Usable in ATEX zone 2

Process protection



An insurance policy for your plant, except better

Non-contacting motion sensors detect changes in motion and speed of conveying, reciprocating, and rotating machinery. Motion sensors can warn of equipment malfunction and shut down machinery in case of slowdown or failure.

They are rugged and perform even in harsh industrial conditions.

Non-invasive acoustic sensors detect high frequency acoustic emissions caused by materials in motion. They can detect conditions of flow/no flow or high/low flow to warn of blockages, product absence, or equipment failure. The sensors are located outside of the process, accurately detecting conditions without wear on the sensor.

	Motion detection and flow detection as headline in the blue line			Flow detection	
	SITRANS WM300 MFA	Milltronics MFA 4p	SITRANS WM100	SITRANS AS100	SITRANS CU02
Article No.	7MH7701-0AA00-0A	7MH7144	7MH7158	7MH7560	7MH7562
Type	Highly sensitive dual setpoint motion sensor system, used with up to 2 MSP and XPP probes	Highly sensitive single setpoint motion sensor system used with MSP probes	Heavy-duty stand-alone zero-speed alarm switch	Acoustic sensor detects high frequency emissions from friction or the impact of dust, powders, and granules and solids in motion	Operates with the SITRANS AS100 to provide reliable continuous protection for bulk solids flow; two relays are fully programmable
Key features	<ul style="list-style-type: none"> Up to 100 mm (4 inch) gap between target and probe Setpoint adjustment range 2 to 5 000 Hz 	<ul style="list-style-type: none"> 2 relays Rugged probe design Industry leading 4" (100 mm) sensor to target gap Several motion probes available, also for stand-alone operation 	<ul style="list-style-type: none"> 1 relay Rugged probe design Industry leading 4" (100 mm) sensor to target gap 	<ul style="list-style-type: none"> Non-invasive material detection Compact design Stainless steel construction for corrosion resistance 	<ul style="list-style-type: none"> 2 programmable relays Compact design Local user programming and display



Sales and support

Custom engineering

Siemens provides custom-engineered products to solve your special application needs. From material compatibility challenges to unique size requirements, Siemens' custom engineering team can help.

Service around the world

Plants must function reliably at all times. Efficient and effective process instrumentation and analytics are an indispensable requirement to this end. You also need to be certain of fast and competent service from your supplier. Siemens is a global company that reacts locally. Whether you require consulting, quick delivery, or installation of new devices, the Siemens network of specialists is available to you around the world, wherever your location.

Service around the world

Our online support system offers rapid, comprehensive assistance regardless of time or location. From product support to service information, Siemens Industry online support is your first choice – around the clock, the fast way 365 days a year.

The fast way to your experts:

hotline.siwarex@siemens.com

+49 721 667-1200

[siemens.com/automation/service&support](https://www.siemens.com/automation/service&support)

Siemens weighing trainings – on-site and online

The training center in Karlsruhe provides a wide range of industrial scales across nearly 200 square meters. From conveyor belt scales to dosing and bagging, a wide variety of SIWAREX application possibilities can be seen in action. Moreover, the training center has a spacious training room and numerous training models.

Individual training concept

The weighing trainings can either take place in the weighing technology center in Karlsruhe, but also directly on the customer's site.

In the standard training portfolio we offer trainings for

- basic trainings with the following content: mechanic and electronic, get to know the basic terms and applications regarding load cells, mounting units and SIWAREX electronics

- static applications, such as platform or hopper scales – available in the levels basic, advance, expert

- mass dynamics applications regarding belt scales and weighfeeders – available in the levels basic, advance, expert

Besides that you are also able to plan your training individually tailored to your needs in agreement with our training experts.





All trainings can be offered in different languages

A complete overview of the training portfolio you find here:
English: sitrain-learning.siemens.com

In addition to our on-site trainings we also offer you various online trainings in English and German.

Please contact us, if you are interested: info@sitrain.com

Also have a look at our various online tutorials we offer you in Youtube.

Under the following playlist link, you will find a range of films concerning calibration, dosing, filter settings, integration in SIMATIC and much more.



Published by
Siemens AG

Digital Industries
Process Automation
Östliche Rheinbrückenstr. 50
76187 Karlsruhe, Germany

For the U.S. published by
Siemens Industry Inc.

100 Technology Drive
Alpharetta, GA 30005
United States

Article No.: DIPA-B10259-00-7600
Dispo 27900
WS 09210.0
Printed in Germany
© Siemens 2021

Subject to changes and errors. The information provided in this brochure contains descriptions or performance characteristics which, in case of actual use, do not always apply as described or which may change as a result of further development of the products. The desired performance characteristics are only binding if expressly agreed in the contract. Availability and technical specifications are subject to change without notice.

All product designations may be trademarks or product names of Siemens AG or supplier companies, the use of which by third parties for their own purposes may violate the rights of the owners.

[siemens.com/weighing](https://www.siemens.com/weighing)