

**CO stats**  
**COST**

**KEY POINTS**

- Range from 0 to 500 ppm
- RCR relay output 3A/230 Vac, power supply 24 Vac/Vdc
- Visual and audible alarm, red led in front
- ABS V0 IP65 housing (according to the model)
- "¼ turn" system mounting with wall-mount plate
- Housing with simplified mounting system



**FEATURES OF HOUSING**

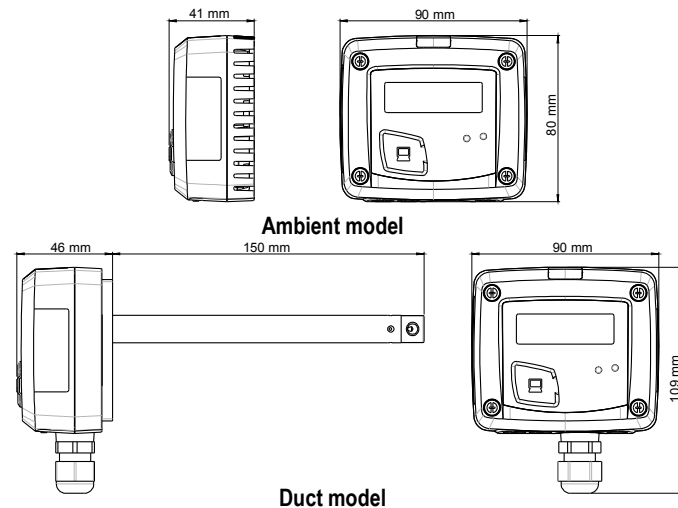

**Material :** ABS V0 as per UL94

**Protection :**

- duct model : IP65
- ambient model : IP20

**Display :** LCD 10 digits. Size : 50 x 17 mm

**Height of digits :** Values : 10 mm ; Units : 5 mm

**Cable gland (only for duct model) :** For cables Ø 8 mm maximum

**Weight :** 138 g (ambient model) ; 150 g (duct model)

**TECHNICAL FEATURES**

<b>Unit of measurement</b>	ppm
<b>Measuring range</b>	From 0 to 500 ppm
<b>Accuracy*</b>	±3 ppm or 3% of the reading value
<b>Type of sensor</b>	Electrochemical sensor
<b>Life-time of the sensor</b>	5 years
<b>Response time</b>	T63 = 35 s
<b>Resolution</b>	0.1 ppm
<b>Type of fluid</b>	Air and neutral gas
<b>Operating temperature</b>	From 0 to +50 °C
<b>Storage temperature</b>	From -10 to +70 °C

\*All the accuracies indicated in this technical datasheet were stated in laboratory conditions, and can be guaranteed for measurements carried out in the same conditions, or carried out with calibration compensation.

**PART NUMBER**

To order, just add the codes to complete the part number :

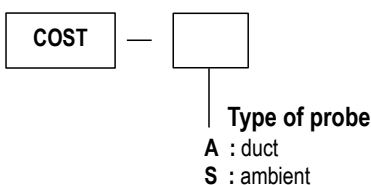

**Example : COST-A**  
CO stat with duct probe

## TECHNICAL SPECIFICATIONS

<b>Output</b>	1 RCR relay 3 A / 230 Vac
<b>Power supply</b>	24 Vac/Vdc $\pm 10\%$
<b>Consumption</b>	2 VA
<b>Relay and alarm status</b>	Red led in front and internal buzzer
<b>Electromagnetical compatibility</b>	EN61326
<b>Electrical connection</b>	Terminal block for cables $\varnothing 0.05$ to 2.5 mm <sup>2</sup>
<b>PC communication</b>	USB-mini Din Kimo cable
<b>Environment</b>	Air and neutral gas

## CONNECTIQUES

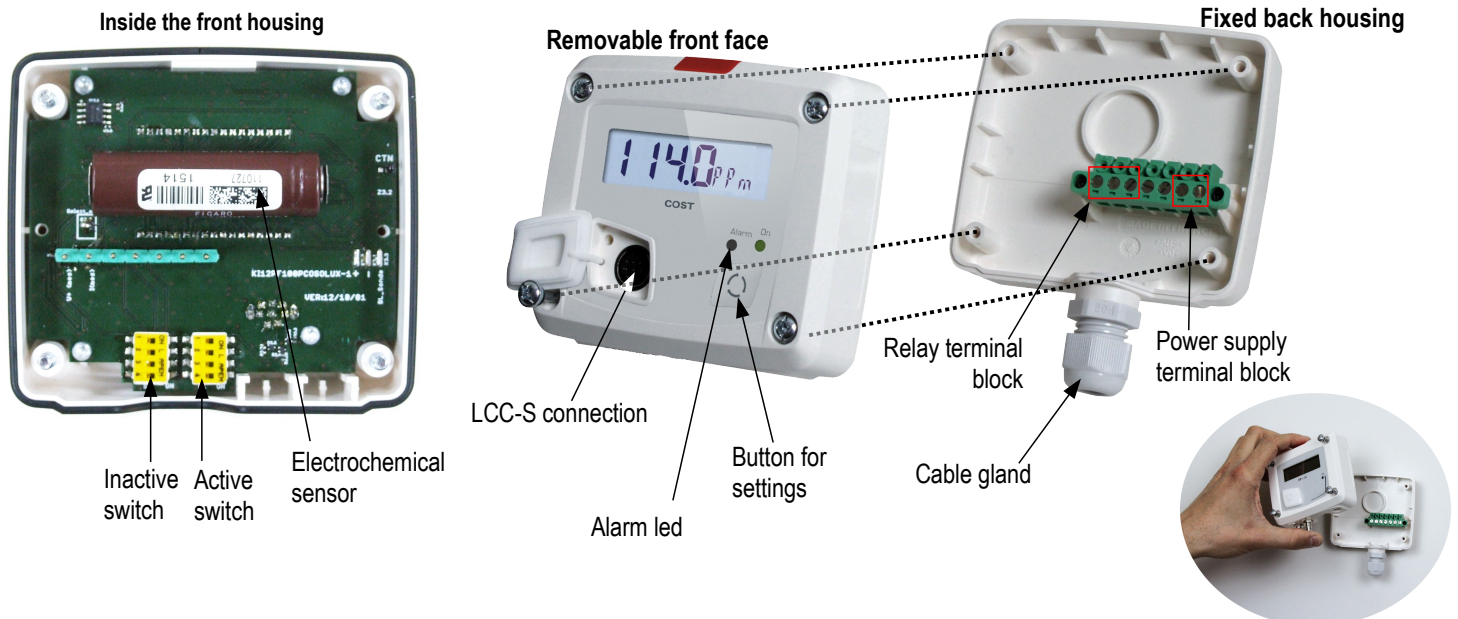

## ELECTICAL CONNECTIONS – as per *NFC15-100 standard*



This connection must be made by a qualified technician. **To make the connection, the transmitter must not be energized.**

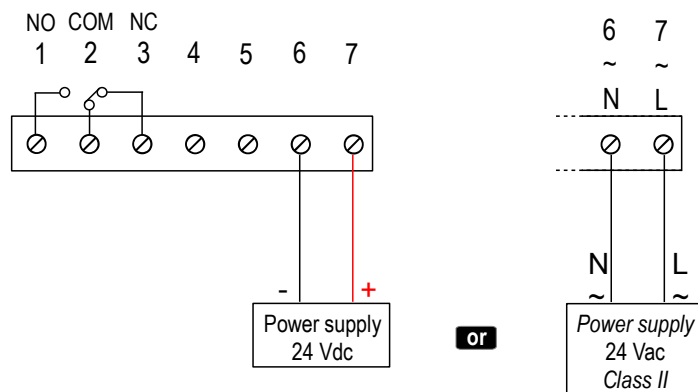

## SETTINGS AND USE OF THE TRANSMITTER

### Thresholds configuration

The button  allows to activate or not an alarm (threshold), to set the action of the alarm (edge), to set the threshold(s) value, to set the time-delay and to acknowledge the alarm.

### Working principle :

- By pressing on the button more than 3 seconds, you can validate the setting and go to the next setting.
- By pressing quickly on the button, you can increment a value and scroll down the different option or values.

### Setting procedure :

- **Activate or deactivate an alarm :**
  - > Press on the button for 3 seconds, “CONF” is displayed then “NEG”, meaning that the relay is in negative security, it is excited during an alarm condition.
  - > If needed, press quickly on the button to switch the relay in positive security, the relay is de-energized during an alarm condition or a current breaking, “POS” is displayed.

- > Press 3 s on the button, “**Buzz**” screen is displayed with “**ON**” or “**OFF**” blinking. Briefly press on the button to activate (“**ON**”) or deactivate (“**OFF**”) (according to the last saved configuration) the buzzer during an alarm condition.
- > Press 3 s on the button, “**Alarm**” screen is displayed with “**On**” or “**Off**” blinking (according to the last saved configuration).
- > Press quickly on the button, the display changes from “**On**” (activated alarm) to “**Off**” (deactivated alarm).
- > Press 3 seconds on the button to confirm the setting. If the alarm is deactivated, the instrument displays the measurement ; if the alarm is activated, the instrument displays the following setting.

• **Set the action of the alarm (rising edge or falling edge)**

The edge determines the action of the alarm according to the trespassing direction of the threshold(s).

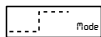
 Rising edge (1 threshold) : the alarm goes off when the measurement **exceeds** the threshold and stops when it is **below** the threshold.

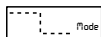
 Falling edge (1 threshold) : the alarm goes off when the measurement is **below** the threshold and stops when it **exceeds** the threshold.

 Monitoring (2 thresholds) : the alarm goes off when the measurement is outside the defined low and high thresholds.

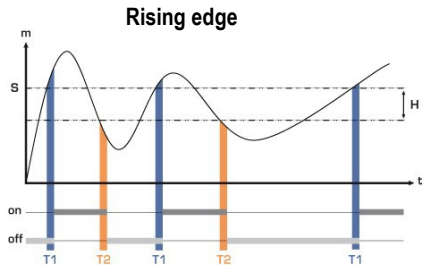

Measurement (m) > Threshold (S) during the time-delay T1 → Alarm activation.

Measurement (m) < Threshold (S) - Hysteresis (H) during the time-delay T2 → Alarm deactivation.

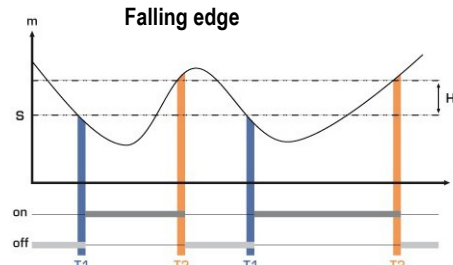

Measurement (m) < Threshold (S) during the time-delay T1 → Alarm activation.

Measurement (m) > Threshold (S) + Hysteresis (H) during time-delay T2 → Alarm deactivation.

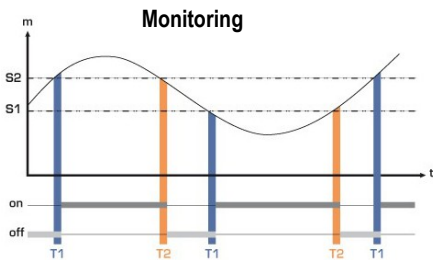

The alarm goes off when the measurement is outside the low and high thresholds.

- > Press briefly on the button to select the trespassing direction then press the button more than 3 seconds to validate this direction and set the thresholds.

• **Set the threshold(s) value**

The first digit blinks, it corresponds to the positive (0) or negative (-) setting of the threshold value. Press briefly on the button to select the sign for the threshold value. Press on the button more than 3 seconds to validate.

The second digit blinks, press briefly on the button to scroll the numbers. Press the button more than 3 seconds to validate.

Repeat the process until the last digit to configure the threshold value, validate the threshold and go to the following setting.

If the monitoring edge has been selected, the transmitter displays the setting of the second threshold.

• **Set the hysteresis**

The hysteresis is only for the rising edge and the falling edge modes.

In rising edge mode, the hysteresis allows to the transmitter to stay in alarm when the measurement is between the threshold and the threshold minus the hysteresis.

Ex : for a 100 ppm threshold and a 10 ppm hysteresis, the instrument will stay in alarm when the measurement will be between 100 and 90 ppm.

In falling edge mode, the hysteresis allows to the transmitter to stay in alarm when the measurement is between the threshold and the threshold plus the hysteresis.

Ex : for a 100 ppm threshold and a 10 ppm hysteresis, the instrument will stay in alarm when the measurement will be between 100 and 110 ppm.

The first digit blinks, set it pressing the button briefly several times then press on the button more than 3 seconds to set the following digit..

Once the hysteresis is set, press the button more than 3 seconds to validate and set the time-delays.

• **Set the time-delay 1 and the time-delay 2 (600 seconds maximum)**

- > In rising edge mode, the time-delay 1 corresponds to the time lag before the alarm goes off when the threshold has been reached. The time-delay 2, corresponds to the time lag before the alarm stops when the measurement is lower than the threshold minus the hysteresis.

Setting procedure : “**Time 1**” for the time-delay 1 is displayed then the time in second. The first digit blinks, press briefly on the button and scroll the figures. Press on the button more than 3 seconds to validate. Repeat the process until the last digit to set the time-delay 1 value (from 0 to 600 s) and validate. “**Time 2**” is displayed the the time in second. Repeat the process to set the time-delay 2.

- > In falling edge mode, the time-delay 1 corresponds to the time lag before the alarm goes off when the threshold has been reached. The time-delay 2, corresponds to the time lag before the alarm stops when the measurement is lower than the threshold plus the hysteresis.

The setting procedure is the same as the rising edge procedure.

- > In monitoring mode, the alarm of the transmitter goes off when the measurement is below the lower threshold and higher the high threshold. The time-delay 1 corresponds to the time lag before the alarm goes off when the measurement is below the lower threshold and higher the high threshold. The time-delay 2 corresponds to the time lag before the alarm stops when the measurement is between the lower and higher thresholds.

The setting procedure is the same as the rising edge procedure.

The setting of time delays is done, the measurement is displayed.

## CONFIGURATION VIA LCC-S SOFTWARE (option)

**The software allows to set the alarms, the thresholds, and the time-delay of the instrument.**

- To access the configuration via software :
  - Set the DIP switches as shown beside.
  - Connect the cable of the LCC-S to the connection of the transmitter.
- Please refer to the user manual of the LCC-S to make the configuration.

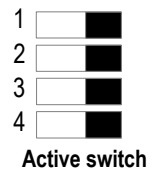

**The configuration of the parameters can be done either with the DIP switch or via software (you can not combine both solutions)**

## MOUNTING

To mount the transmitter, mount the ABS plate on the wall (drilling :  $\varnothing 6$  mm, screws and pins are supplied).

Insert the transmitter on the fixing plate (see A on the drawing beside). Rotate the housing in clockwise direction until you hear a "click" which confirms that the transmitter is correctly installed.



**Ambient model has not any fixing plate.**

**4 fixing holes are inside the back housing. Use them to install the transmitter on the required location.**

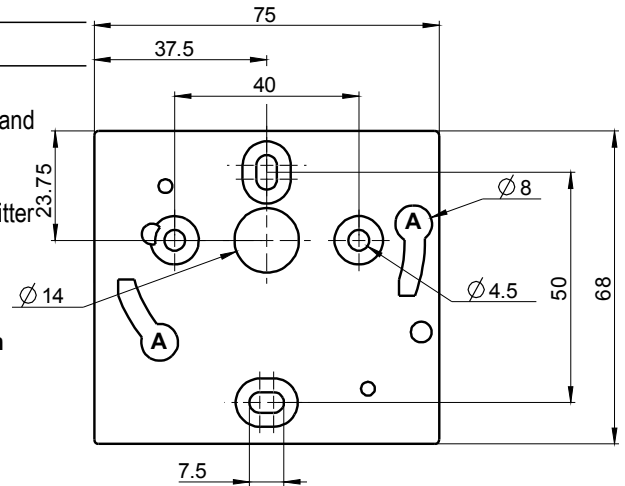

## POSITIONING OF THE PROBE

For duct models, the positioning of the probe is important to get accurate measurements : the hole located next to the screw at the end of the probe must face the air flow.

Procedure to modify the positioning of the end of the probe :

- > Unscrew the screw.
- > Turn the end of the probe : the hole must face the air flow.
- > Replace the screw.

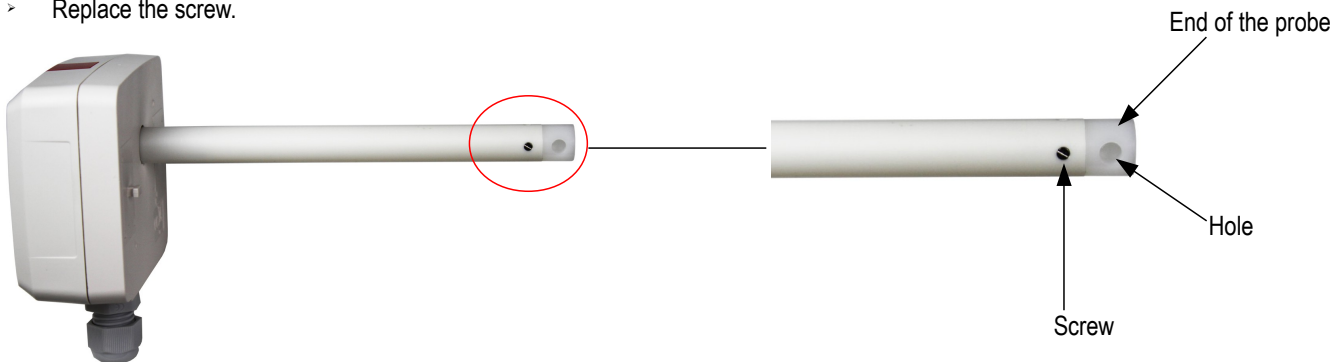

## MAINTENANCE

Please avoid any aggressive solvent. Please protect the transmitter and its probes from any cleaning product containing formalin, that may be used for cleaning rooms or ducts.

## OPTIONS AND ACCESSORIES

- **KIAL-100A** : Power supply class 2 , 230 Vac input, 24 Vac output
- **LCC-S** : configuration software with USB cable

[www.kimo.fr](http://www.kimo.fr)

Distributed by :



EXPORT DEPARTMENT

Tel : + 33. 1. 60. 06. 69. 25 - Fax : + 33. 1. 60. 06. 69. 29

e-mail : [export@kimo.fr](mailto:export@kimo.fr)