



CALEC® ST II

Multi-protocol heating / cooling energy calculator

For heating, air-conditioning, refrigeration or systems with thermal alternative energy

Application

The CALEC® ST II is used for energy metering in split systems which are equipped with passive or active pulsed flow meters and 2-wire or 4-wire Pt100 or Pt500 temperature sensors. Integrated power supplies for flow transmitters simplify the connection of flow meters and make it easy to select the appropriate application for water and other heating or cooling media.

Choose from our wide range of volume-measuring elements. Our advisers will be pleased to help you select the right ones for your needs.

Obligatory calibration and type-approval

In most countries energy metering systems used for commercial purposes are subject to compulsory verification. The devices comprising the metering system must all possess official pattern approval. CALEC® ST II has been approved according to both the European Measuring Instruments Directive 2014/32/EU and the German PTB K 7.2 directive for cooling meters.

Officially verified heat and cooling meters must be reverified before the verification period has expired. The operator is responsible for compliance with this requirement. (Re-)Verification includes all parts (temperature and flow sensors, calculator) forming the complete heat meter. The plug-in calculator minimises the cost of recalibration as the wiring does not have to be disconnected, and device-specific data remain stored in the configuration memory in the base of the housing.

The "IMP EBS" option makes it even easier to set up devices which require calibration, as the pulse value and installation side can be set on-site.

You can use AMBUS® WIN II, which is available as a free download, for parameterisation, adjustment to new conditions, and to read data from the device

Basic function and measuring principle

A heat or cooling meter is composed of the following individually approved sub-assemblies:

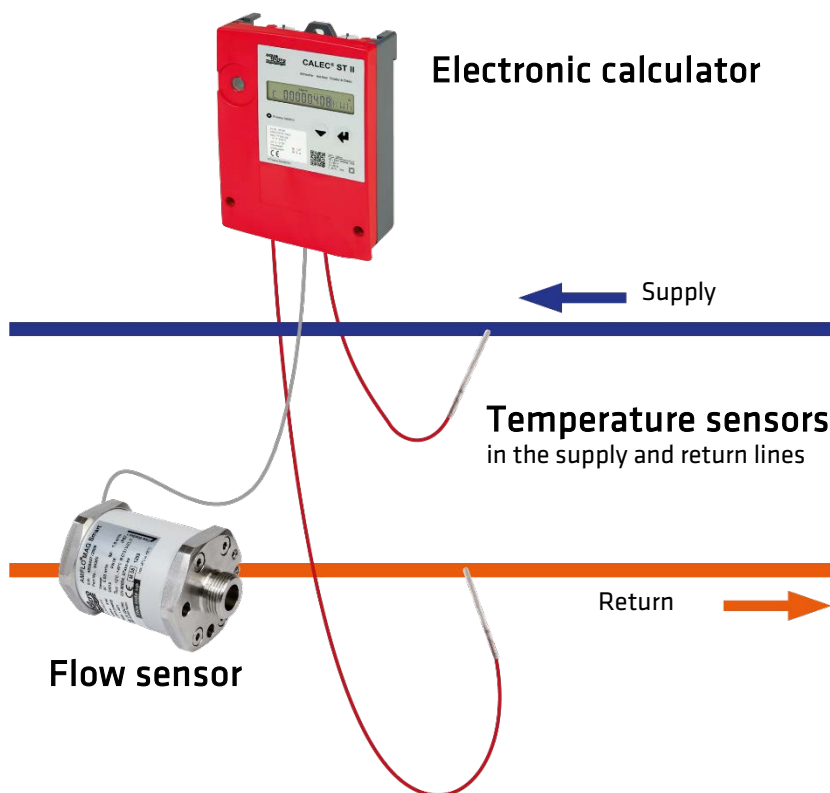

Example: Cooling meter

CALEC® ST II

Multi-protocol heating / cooling energy calculator

The thermal output (P) of a pipe-conduit network is based on a measurement of the flow temperature, return-flow temperature and volume flow of the heat transfer medium.

$$P = \text{Volume rate of flow} \times (T \text{ heat side} - T \text{ cold side}) \times k$$

T heat side:: For heating, flow temperature, for cooling, return temperature

T cold side: For heating, return temperature, for cooling, flow temperature

k: Wärmekoeffizient (Funktion unter Berücksichtigung der temperaturabhängigen Eigenschaften des Wärmeträgers wie spezifische Wärme und Dichte)

Energy can be determined by integration of output. The formula shows that, in order to meter energy, the specific heat and density of the heat transfer medium must be expressed in relation to the temperature of the counter mechanism. The following factors (among others) also have a decisive influence on metering accuracy:

- The static accuracy and stability of the temperature-measuring procedure
- The counter cycle of the temperature-measurement system, and the volume flow used to detect dynamic factors

CALEC® ST II is ideally equipped for use in demanding metering tasks, thanks to:

- The use for temperature-measuring purposes of a high-resolution AD converter (20 bit) designed with long-term stability in mind and equipped with self-calibration and filter functions
- Short counter-cycle (mains version: 1 s)
- The ability to use high-resolution mechanical or electronic flow indicators operating at pulse frequencies of up to 200 Hz (mains version)

NAMUR transmitters or electronic transmitters with external power supply can be powered directly from the CALEC® ST II.

Flow-rate measurement

The system is compatible with all standard flow meters which use a pulse output. The pulse value should be set as low as possible if continuous measurement or high-resolution energy metering is required.

The mains-powered CALEC® ST II can operate with contactors up to 20 Hz and electronic transmitters (NAMUR, etc.) with pulse frequencies of up to 200 Hz.

The flexible calculation of heat capacity and density facilitates accurate energy measurement, not only for water circuits, but also for a variety of other heating or refrigeration media.

The point of installation of the flow meter is crucially important, because the volume-to-mass conversion is based on the temperature detected at this point.

It is preferable to fit the flow transmitter to the section of the line where the temperature is closest to room temperature.

Temperature measurement

The CALEC® ST II is fitted with two highly-accurate temperature-measurement inputs, which are each connected to type-approved, paired temperature sensors in two- or four-wire configuration. The planning of systems should conform to heat meter standard EN 1434, parts 2 and 6. EN 1434-4 stipulates that only sensors of the same design and length should be paired together.

The counter mechanism is available in either Pt 100 or Pt 500 configuration.

Thermal energy is measured from a temperature difference from dT above (respectively below) 0 K. The CALEC® ST II is the ideal solution for air-conditioning or cooling installation when used with appropriate temperature sensors and flow meters for cooling.

Data communication

The CALEC® ST II is fitted with two separate interfaces for data transfer to higher-level systems. These two interfaces can be configured as M-Bus, LON TP-F10, Modbus RTU, N2Open, BACnet MS/TP and KNX, or any combination of the above. For parameterizing and configuration purposes, there is integrated an optical M-Bus Interface.

M-Bus-Interface

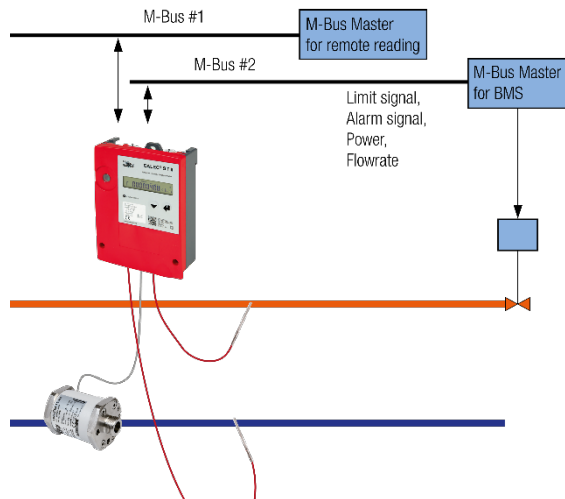

The M-Bus has established itself as the standard for meter reading as it has been standardised in EN 13757, and offers a variety of other features.

Advantages include:

- Easy installation
- High cost-effectiveness
- Multi-vendor capability.

Not only standard data such as meter readings and current values can be read out over the M-Bus interface, but also all additional data available from the device, for example billing and logger values. With CALEC® ST II primary addresses and baud rates can be set with the operating keys, eliminating the need for a PC when commissioning the system. The M-Bus is a single master bus, i.e. a slave can usually only communicate with a master. However, sometimes it can also be necessary to transmit data to two different M-Bus masters. The CALEC® ST II provides a simple solution as the device is equipped with two configured interfaces.

LON-Interface

A LON network can combine BMS and meter readout in one system. LON (Local Operating Network) is a multi-master system with intelligent nodes which can use different transmission media. For CALEC® ST II a LON interface (FTT-10A) for transmissions over twisted pair cabling is available. An outstanding feature of the LON technology is its interoperability which guarantees that the Building automation remains operational beyond the service-life of its individual components. CALEC® ST II is the first energy calculator to be certified according to LONMARK® 3.4. This means lower costs and reduced delivery date risks for system integration. LONMARK® 3.4 certification means, among other things:

- Assurance of communication functionality and data availability
- Low integration costs since standard tools can be used and all features required by LONMARK® are available (object library, XIF files, service LED, service key, etc.).

Modbus RTU Interface

The Modbus interface allows direct connection of CALEC® ST II to a Modbus controller. The Modbus protocol as de facto standard in control and building management systems is widely used since it is an open protocol (www.modbus.org). It is based on a master/slave architecture and allows for a simple system integration by means of a mapping table. Modbus RTU uses the physical layer of the RS485 interface.

N2Open-Interface

CALEC® ST II can communicate directly with N2Open controllers (e. g. from the JCI company) by means of the N2Open interface. N2Open also uses the physical layer of the RS485 interface.

BACnet MS/TP-Interface

BACnet MS/TP is now a widely-used open standard in building automation. The CALEC® ST II with BACnet MS/TP interfaces facilitates integration into BACnet networks without the use of gateways. the physics of the RS485 interfaces is used for transmission.

KNX-Interface

As a worldwide open standard for home and building system technology KNX starts its implementation as „home automation“ in particular for high quality residential complexes. CALEC® ST II expands its interface variety now with an additional, important communication interface – KNX.

LoRa-Interface

As a radio technology communication for IoT “Internet Of Things” Solution dedicated for Smart City, Smart Building, Industry or Agriculture applications, CALEC® ST II allows now to be connected to a LoRa Wireless fixed network for automatic readout, collecting and monitoring of data.

Digital In- and Output

The CALEC® ST II can be fitted with two digital-signal interfaces, which can be configured - by means of a switch - as either inputs or outputs. These signals can be used to process counter impulses, or to warn when limit values have been exceeded, or to transmit alarm messages to the building-management system.

Limit-value signals

Digital output signals can be used to emit limit-value monitoring signals. The following parameters can be monitored in this respect:

Factor	Display
Temperature on "hot" side	t-hot
Temperature on "cold" side	t-cold
Temperature difference	t-diff
Output	POUEr
Flow	FLOU
Mass flow	MAS-FLOU
C-factor	C-Factor
Density	dEnSitY

1. Function of one-sided limit-value monitoring (Limit1)

If an adjustable maximum limit is exceeded or if the reading fails to reach an adjustable minimum, the output signal switches over, hysteresis (0 - 10 %) and control direction are selectable as required. While the excess-reading remains in force, the meter (showing "Cnt" for "counter") calculates the total duration of the error for inspection purposes.

2. Function of two-sided limit-value monitoring (Limit2)

If an adjustable maximum limit is exceeded **and** if there is failure to reach an adjustable minimum, the functions operate in a similar way to those of Limit1.

Alarm message

The microprocessor monitors the temperature sensor and internal functions, and displays any resulting error messages. This information can also be used to generate an alarm signal via the digital outputs.

Analogue outputs

CALEC® ST II can be equipped with two passive analogue outputs. An external power supply is required for operating purposes. The out- puts are electrically isolated from each other and from the counter mechanism. The current per channel can be adjusted within a range of 0 - 20 mA or 4 - 20 mA. The following readings can be emitted as current signals:

Factor	Display
Temperature on "hot" side	t-hot
Temperature on "cold" side	t-cold
Temperature difference	t-diff
Output	POUEr
Flow	FLOU
Mass flow	MAS-FLOU
C-factor	C-Factor
Density	dEnSitY

Additional functions

Billing date values

With the 12 freely programmable billing date values, the indexes can be memorized (e.g. monthly) for defined dates and consulted at any time.

Data logging

The CALEC® ST II can record up to 500 data records in a ring buffer at intervals of min, hour, day, week, month.

Factor	Display
Date and Time	-
Energy	Total
Volume	Total
Auxiliary meter 1	Total
Auxiliary meter 2	Total
Downtimes	Total
Alarm hours	Total
Time stamp peak power	(Integration intervall 15 min.)
Power	Peak value
Flow	Peak value
Temperature warm side	Peak value
Temperature cold side	Peak value

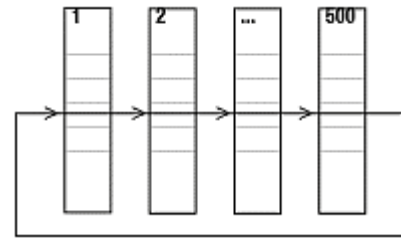

Simultaneous readout

In a plant with many meters, a considerable time difference between readings can occur if these are read out sequentially. CALEC® ST II avoids this problem with the "Freeze" command. A broadcast command instructs all meters simultaneously to store the required value after which they can be read out sequentially.

Low-flow OFF function

The system is factory-adjusted to carry out an energy calculation as soon as a temperature difference of >0 (when measuring heat) or <0 (when measuring cold) is detected. If, for example, a circulation conduit carries, over a long period of time, large quantities of heat transfer medium with a very low temperature difference, this can lead to significant reading errors in temperature measurement. The so-called "lowflow OFF function" can be activated to avoid this, ensuring that energy is only detected when a pre-defined temperature difference is exceeded.

Special functions

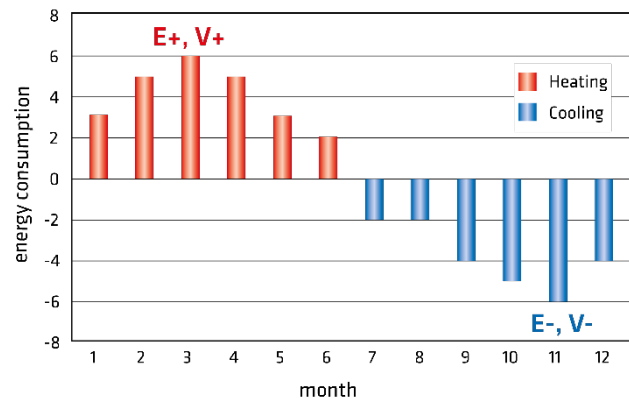

Energy metering in heating/cooling systems

The "bi-directional energy metering" (BDE) option allows emitted energy to be metered even in twin-conduit networks that perform a combined heating and cooling function. The measurement readings for heating and cooling are recorded separately for their corresponding cost-calculation purposes.

Recording of „heat return“

The „Tarif Return Limit“ (TGR) option can be used to set a programmable limit for the return temperature of the heat quantity. If this limit is then exceeded, the flow is „returned“ to the supply network and thus reduces efficiency.

Heat carriers with frost protection additives

The below-freezing temperatures involved in running a refrigeration plant require the use of additional frost protection. This poses an insurmountable problem for many conventional heat meters, as has been investigated in detail in such publications as PTB Report PTB- ThEx-24 of June 2002.

The "Glycol-based heat transfer medium" option available with CALEC® ST II ensures that metering is accurate even in these situations, as energy and volume can be calculated with a sliding scale of values for density and heating capacity for each temperature, independently of that temperature. CALEC® ST II gives accurately polynomial readings for the physical characteristics of 11 widely-used heat transfer liquids with respect to concentration and temperature (see following table).

CALEC® ST II

Multi-protocol heating / cooling energy calculator

Only the heat transfer medium and concentration are established at start-up (see table):

Medium ⁴⁾	Display	Concentration	Temperature range	Manufacturer	Type	Application/observations
Antifrogen N	AntifroN	20 - 60 %	- 120 °C ¹⁾	Clariant	E ²⁾	Confirms to DIN 4757-1; toxicity class 4 For cooling, solar, heating and heat pump systems Low viscosity, requires lower
Antifrogen L	AntifroL	20 - 60 %	- 120 °C ¹⁾	Clariant	P ³⁾	Not harmful to health For pharma-sector, food use
Tyfocor	Tyfocor	20 - 60 %	- 120 °C ¹⁾	Tyfocor	E	See type E
Tyfocor-L	Tyfocor	20 - 60 %	- 120 °C ¹⁾	Tyfocor	L	See type P
DowCal 10	DOUCAL10	30 - 70 %	10- 120 °C ¹⁾	Dow	E	See type E
DowCal	DOUCAL20	30 - 70 %	20- 120 °C ¹⁾	Dow	P	See type P
Glythermin P44	GLYTHP44	40 - 80 %	- 100 °C ¹⁾	BASF	P	FDA-approved in USA, corrosion protection less effective For pharma-sector and food-production plants
Temper -10	TEMPER10	100 % fix	-10...150 °C	Temper	S	Ready-to-use saline solution Not harmful to health, (also for pharma and food sectors) Biodegradable, water-protection class 1 Low viscosity High heat-transfer capacity
Temper -20	TEMPER20	100 % fix	-20...150 °C	Temper	S	
Temper -30	TEMPER30	100 % fix	-30...150 °C	Temper	S	
Temper -40	TEMPER40	100 % fix	-40...150 °C	Temper	S	

Additional products are available on request

1) Minimum temperature depends on concentration -40 to 0°C 3) Based on propylene glycol

2) Based on ethylene glycol 4) All names are registered trademarks of their respective manufacturers.

The following graphs give an example of how the dependency of temperature on specific heat and density can have an important bearing on the final calculation.

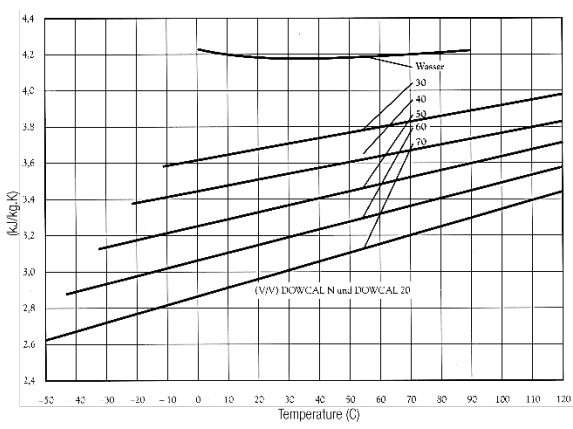
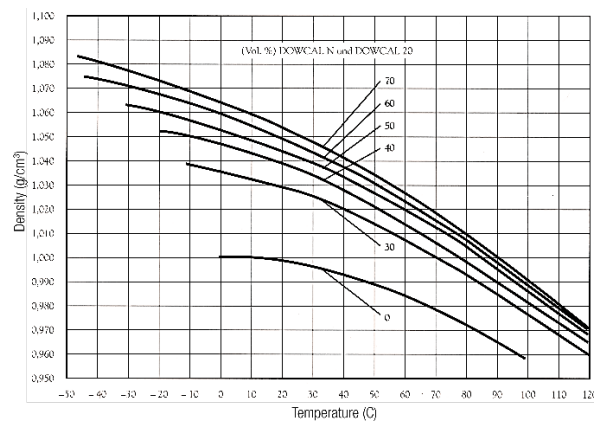

DOWCAL is a registered trademark of the Dow Chemical Company

Solar-powered thermal systems

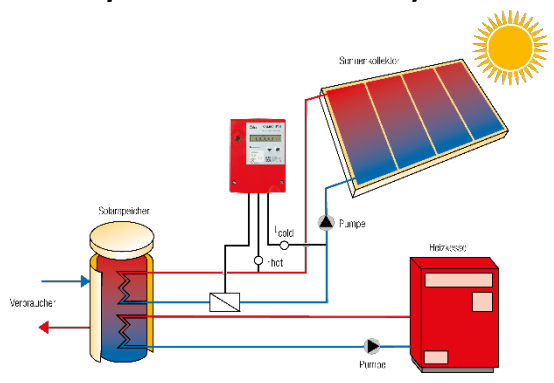

Solar thermal systems likewise pose demanding tasks for energy metering with respect to temperature range and heat transfer medium.

The "Glycol-based heat transfer medium" (GLY) option available with CALEC® ST II also offers an excellent solution in these cases (further details in the section on refrigeration systems).

CALEC® ST II

Multi-protocol heating / cooling energy calculator

CALEC® ST II Flow

The CALEC® ST II Flow configuration is designed for flow-rate measurement purposes. Temperature measurement (“hot” and “cold” side) is disabled in this configuration, i.e. no temperatures are detected or displayed. CALEC® ST II Flow uses the accumulated pulse signals from the flow detector to calculate the current flow-rate reading. These measurement readings can be sent to the display, the analogue outputs and/or the M-Bus, Modbus, LON, BACnet, N2Open or KNX interface interface for reading or further processing.

CALEC® ST II configurations

We will gladly advise you about the available variants.

Controls and displays

Thanks to their logically-structured functioning, all setting adjustments on the CALEC® ST II can be carried out locally and without the use of additional equipment.

Multi-function display



When the device is in operation and the housing is closed the displayed values can be selected using two keys:

In addition to the display text, alarm states are indicated by a red flashing LED in the center of the optical interface.

During operation and when the housing is closed, the displays can be selected via 2 keys:

Control keys

Alarm LED

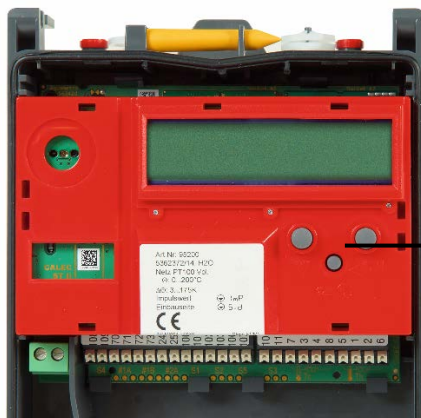

Under the cover, and thus protected by the lead seal, is the Service button, which allows additional service information to be displayed and adjustments to be carried out.

Service button

For professional use, the PC software AMBUS® Win II is available to download from our website. It provides effective support with startup and data analysis.

CALEC® ST II
Multi-protocol heating / cooling energy calculator

The following graph shows the information available at various points on the main operating flowchart, along with the short text designations of various sub-functions:

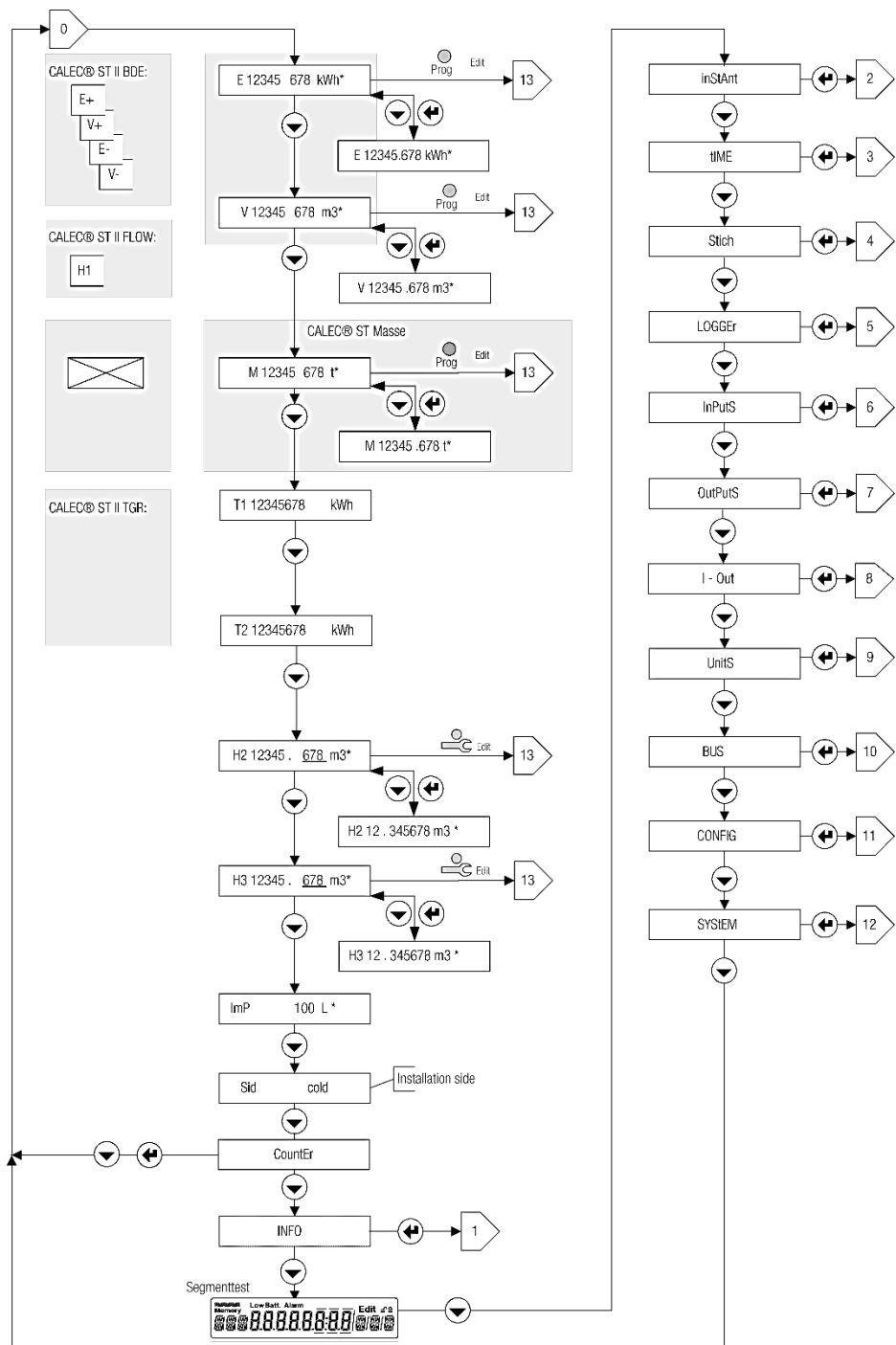

Display	Description
Info	Error message display
InstAnt	Current readings for temperature, output, flow rate, C-factor, density
Time	Date and time
StIch	Critical-date values
LoGGEr	Data-log memory settings
InPutS	Settings and status of signal inputs
OutPutS	Settings and status of signal outputs
I - Out	Settings and status of the mA signal outputs
UnitS	Measurement-unit settings
BUS	M-Bus settings
CONFIG	Further settings (e.g. for glycol-based heat transfer medium)
SYStEM	System data (e.g. firmware version)

Plug-in calculator module

CALEC® ST II

Multi-protocol heating / cooling energy calculator

The energy calculator is housed in a plug-in module. The bottom of the housing (which contains the field wiring) does not have to be removed when recalibrating the unit. Furthermore, device-specific data are retained in the configuration memory (EEPROM) in the bottom of the housing (except parameters that are subject to calibration, like impulse value and installation side).

Housing, dimensions

Housing

Lower section with connection terminals, computer module and cover.

Installation

DIN-standard rail or three-point attachment directly to the wall.

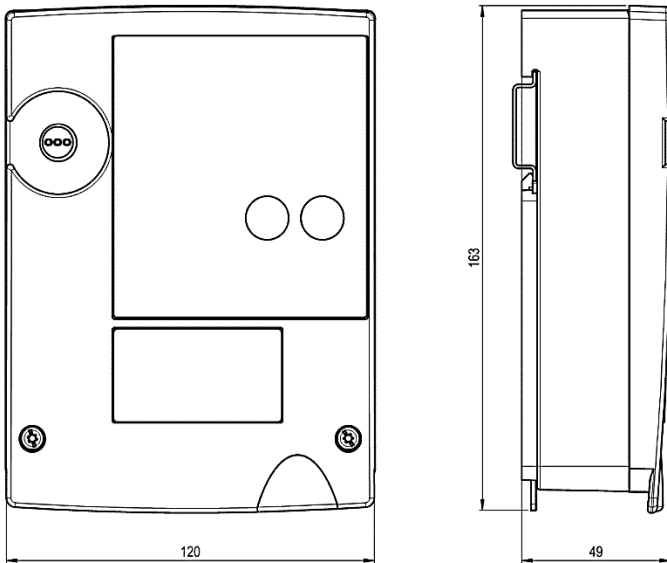

Electrical connections

The wiring layout used depends on device configuration and applicable options. The factory-configured state of the unit is shown on the diagram attached to the inside of the housing cover.

Network version (with M-Bus and low-voltage power supply) (Example)

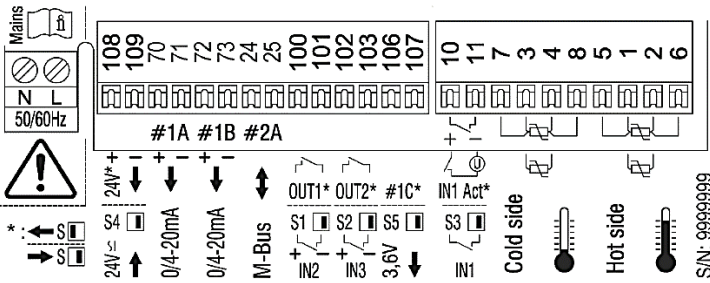

Approval permits

European approval in accordance with the Measuring Instruments Directive (MID) 2014/32/EU, CH-MI004-14020 Approval DE-18-M-PTB as a cooling meter in accordance with PTB K7.2.

Technical data and standards

The following tables contain information on the technical data of the available functions. Please refer to the price list for possible combinations.

Standards		
CE directives	2014/32/EU Measuring Instruments Directive (MID) 2014/30/EU Electromagnetic compatibility (EMC) 2014/35/EU Low voltage directive (LVD) 2012/19/EU Waste Electrical and Electronic Equipment (WEEE) Directive	
Standards	EN 1434, EN 61000-6-1, EN 61000-6-2, EN 61010, DIN 43863-5	
Housing and operating conditions		
Dimensions	W x H x D = 120 x 163 x 49 mm	
Ambient temperature	+5...55 °C, EN 1434 class C	
Storage temperature	0...60 °C	
Humidity	Max. 95% rel. humidity (non-condensing)	
Operating altitude	Up to 2,000 m above sea level	
Protection rating	IP 54	
Terminals	1.5 mm ² spring terminals, Power connection 2.5 mm ² screw terminals	
Basic data for calculator		
Temperature measuring range	0...+200 °C (heat carrier: water) -40...+180 °C (special heat carrier)	
Temperature difference	0...190 K, Approval 3...190 K, 1...190 K in accordance with prEN1434-4:2014	
Temperature sensor	Pt100 or Pt500 in accordance with IEC 751 paired in accordance with EN 1434, 2-wire or 4-wire connection. Max. sensor cable length 4-wire connection 100 m.	
Temperature measurement res.	20-bit resolution, typical ±0.005 K (Ta = 5...55 °C)	
Installation side	Hot or cold side	
Pulse value of the flow sensor	Auflösung 20 Bit, typisch ±0.005 K (Ta = 5...55 °C)	
Pulse values and units for auxiliary inputs and contact outputs	Volume: 0.001...9999.999 ml, l, m ³ , GAL Energy: 0.001...9999.999 Wh, kWh, MWh, MJ, KBTU	
Error limits	Better than those required for calculators in accordance with EN 1434-1. Suitable for combined class 2 heat meters in accordance with EN 1434-1 when used with suitable volume metering units.	
Optical interface	IEC 870-5, M-Bus protocol	
Display		
Display units: volume	m ³ , USGal	
Display units: energy	kWh, MWh, MJ, GJ, KBTU, MBTU	
Data backup in the event of a power failure	In EERPOM >10 years	
Data logger	500 records in ring buffer with all meter readings, 15-Min. maximum of instantaneous values including time stamp of the power peak. Logger interval: 1 min, 1 hour, 1 day, 1 week, 1 month	
Additional functions		
Adjustable low flow cut-off (SMU)	Function for stopping the energy calculation when the temperature difference is too low, ΔT SMU adjustable ΔT = 0 - 2.99 K	
Limit-value monitoring	One-sided or two-sided, hysteresis 0 - 10%, action of the output signal is selectable	
Mains version		
Power supply	100 - 240 V AC, 50/60 Hz, max. 5W (in accordance with EN 1434) 12 - 42 V DC or 12 - 36 V AC, max. 1 VA, (in accordance with EN 1434)	
Calculation cycle	1 s	
Backup battery realtime clock	3.6 V lithium battery	
Low-voltage power supply for flow transmitter		
Supply voltage	Terminals 108/ 109 24 V DC, max.150 mA, el. isolation max. 48V V DC	Terminals 106/ 107 3.6 VDC, max. 2 mA
Flow transmitter	e.g. AMFLO® MAG Smart or active sensors	e.g. AMFLO® SONIC UFA 113

Pulse inputs and outputs																																					
Main input #1 (10/11)	Connecting a pulse generator according to NAMUR, with potential-free contact (reed relay) or SSR (solid state relay), or for active sensors with the following values.																																				
	<table border="1"> <thead> <tr> <th colspan="2">Input passive</th> <th colspan="2">Input active</th> </tr> </thead> <tbody> <tr> <td>Open-circuit voltage</td> <td>8 V</td> <td>Voltage range</td> <td>3...48 VDC</td> </tr> <tr> <td>Short-circuit current</td> <td>8 mA</td> <td>Current signal</td> <td>> 2 mA</td> </tr> <tr> <td>Switching level</td> <td><1.5 mA, >2.1 mA</td> <td>Reverse polarity protection</td> <td>-48 V</td> </tr> <tr> <td>Min. OFF (t off)</td> <td>20 Hz 20 ms</td> <td>Electrical isolation</td> <td>48 V</td> </tr> <tr> <td>Min. ON (t on)</td> <td>20 Hz 3 ms</td> <td>Min. OFF (t off)</td> <td>20 Hz 20 ms</td> </tr> <tr> <td>Min. OFF (t off)</td> <td>200 Hz 2 ms</td> <td>Min. ON (t on)</td> <td>20 Hz 3 ms</td> </tr> <tr> <td>Min. ON (t on)</td> <td>200 Hz 300 µs</td> <td>Min. OFF (t off)</td> <td>200 Hz 2 ms</td> </tr> <tr> <td>Input capacity</td> <td>20 nF</td> <td>Min. ON (t on)</td> <td>200 Hz 300µs</td> </tr> </tbody> </table>	Input passive		Input active		Open-circuit voltage	8 V	Voltage range	3...48 VDC	Short-circuit current	8 mA	Current signal	> 2 mA	Switching level	<1.5 mA, >2.1 mA	Reverse polarity protection	-48 V	Min. OFF (t off)	20 Hz 20 ms	Electrical isolation	48 V	Min. ON (t on)	20 Hz 3 ms	Min. OFF (t off)	20 Hz 20 ms	Min. OFF (t off)	200 Hz 2 ms	Min. ON (t on)	20 Hz 3 ms	Min. ON (t on)	200 Hz 300 µs	Min. OFF (t off)	200 Hz 2 ms	Input capacity	20 nF	Min. ON (t on)	200 Hz 300µs
Input passive		Input active																																			
Open-circuit voltage	8 V	Voltage range	3...48 VDC																																		
Short-circuit current	8 mA	Current signal	> 2 mA																																		
Switching level	<1.5 mA, >2.1 mA	Reverse polarity protection	-48 V																																		
Min. OFF (t off)	20 Hz 20 ms	Electrical isolation	48 V																																		
Min. ON (t on)	20 Hz 3 ms	Min. OFF (t off)	20 Hz 20 ms																																		
Min. OFF (t off)	200 Hz 2 ms	Min. ON (t on)	20 Hz 3 ms																																		
Min. ON (t on)	200 Hz 300 µs	Min. OFF (t off)	200 Hz 2 ms																																		
Input capacity	20 nF	Min. ON (t on)	200 Hz 300µs																																		
Switchable input and output Output #1/ input #2 (100/101)	<table border="1"> <thead> <tr> <th colspan="2">Input passive</th> <th colspan="2">Output</th> </tr> </thead> <tbody> <tr> <td>Open-circuit voltage</td> <td>8 V Max.</td> <td>Contact rating</td> <td>48 VDC, 100 mA</td> </tr> <tr> <td>Short-circuit current</td> <td>800 µA</td> <td>Electrical isolation</td> <td>48 V</td> </tr> <tr> <td>Switching level</td> <td><1.5 mA, >2.1 mA</td> <td>Contact resistance (on)</td> <td><30 Ohm</td> </tr> <tr> <td>Min. OFF (t off)</td> <td>20 Hz 20 ms</td> <td>Contact resistance (off)</td> <td>>10 MOhm</td> </tr> <tr> <td>Min. ON (t on)</td> <td>20 Hz 3 ms</td> <td>Pulse frequency</td> <td>max. 4 Hz</td> </tr> <tr> <td>Min. OFF (t off)</td> <td>200 Hz 2 ms</td> <td>Pulse width</td> <td>100 ms</td> </tr> <tr> <td>Min. ON (t on)</td> <td>200 Hz 300 µs</td> <td></td> <td></td> </tr> <tr> <td>Input capacity</td> <td>20 nF</td> <td></td> <td></td> </tr> </tbody> </table>	Input passive		Output		Open-circuit voltage	8 V Max.	Contact rating	48 VDC, 100 mA	Short-circuit current	800 µA	Electrical isolation	48 V	Switching level	<1.5 mA, >2.1 mA	Contact resistance (on)	<30 Ohm	Min. OFF (t off)	20 Hz 20 ms	Contact resistance (off)	>10 MOhm	Min. ON (t on)	20 Hz 3 ms	Pulse frequency	max. 4 Hz	Min. OFF (t off)	200 Hz 2 ms	Pulse width	100 ms	Min. ON (t on)	200 Hz 300 µs			Input capacity	20 nF		
Input passive		Output																																			
Open-circuit voltage	8 V Max.	Contact rating	48 VDC, 100 mA																																		
Short-circuit current	800 µA	Electrical isolation	48 V																																		
Switching level	<1.5 mA, >2.1 mA	Contact resistance (on)	<30 Ohm																																		
Min. OFF (t off)	20 Hz 20 ms	Contact resistance (off)	>10 MOhm																																		
Min. ON (t on)	20 Hz 3 ms	Pulse frequency	max. 4 Hz																																		
Min. OFF (t off)	200 Hz 2 ms	Pulse width	100 ms																																		
Min. ON (t on)	200 Hz 300 µs																																				
Input capacity	20 nF																																				
Switchable input and output Output #2/ input #3 (102/103)	<table border="1"> <thead> <tr> <th colspan="2">Input passive</th> <th colspan="2">Output</th> </tr> </thead> <tbody> <tr> <td>Open-circuit voltage</td> <td>8 V</td> <td>Contact rating</td> <td>48 VDC, 100 mA</td> </tr> <tr> <td>Short-circuit current</td> <td>800 µA</td> <td>Electrical isolation</td> <td>48 V</td> </tr> <tr> <td>Switching level</td> <td><1.4, >3.2 kOhm</td> <td>Contact resistance (on)</td> <td><30 Ohm</td> </tr> <tr> <td>Pulse length t off</td> <td>20 ms</td> <td>Contact resistance (off)</td> <td>>10 MOhm</td> </tr> <tr> <td>Pulse length t on:</td> <td>3 ms</td> <td>Pulse frequency</td> <td>max. 4 Hz</td> </tr> <tr> <td>Max. frequency</td> <td>20 Hz</td> <td>Pulse width</td> <td>100ms</td> </tr> <tr> <td>Input capacity</td> <td>20 nF</td> <td></td> <td></td> </tr> </tbody> </table>	Input passive		Output		Open-circuit voltage	8 V	Contact rating	48 VDC, 100 mA	Short-circuit current	800 µA	Electrical isolation	48 V	Switching level	<1.4, >3.2 kOhm	Contact resistance (on)	<30 Ohm	Pulse length t off	20 ms	Contact resistance (off)	>10 MOhm	Pulse length t on:	3 ms	Pulse frequency	max. 4 Hz	Max. frequency	20 Hz	Pulse width	100ms	Input capacity	20 nF						
Input passive		Output																																			
Open-circuit voltage	8 V	Contact rating	48 VDC, 100 mA																																		
Short-circuit current	800 µA	Electrical isolation	48 V																																		
Switching level	<1.4, >3.2 kOhm	Contact resistance (on)	<30 Ohm																																		
Pulse length t off	20 ms	Contact resistance (off)	>10 MOhm																																		
Pulse length t on:	3 ms	Pulse frequency	max. 4 Hz																																		
Max. frequency	20 Hz	Pulse width	100ms																																		
Input capacity	20 nF																																				
Interface options for battery and mains versions																																					
M-Bus																																					
M-Bus Interface	Factory settings in accordance with EN 13757-2/-3																																				
Addresses	Primary address: 0 / Secondary address: Serial number																																				
Baud rate	2400 Baud																																				
Options for mains version																																					
Modbus RTU																																					
Physical layer und address	Factory settings RS 485, / address: 1																																				
Baud rate	19200																																				
Address range (slave)	1...247																																				
Parity	Even																																				
Function Code	03: Read holding register																																				
LON Interface																																					
Type	Factory settings LON TP-FT 10 free topology (2-wire twisted pair), certified i.a.w. LONMARK® 3.4																																				
Baud rate	78 kBaud																																				
Maximum bus length	500 m / 2,700 m with/without termination resistors, 64 nodes per segment																																				
BACnet MS/TP																																					
Physical layer and AMT ID	Factory settings RS 485 / ID: 431																																				
BACnet device profile and instance	B - ASC / the last 5 digits of the serial number																																				
BACnet MAC address	The last 2 digits of the serial number																																				
Baud rate and mode	Automatic / master																																				
N2Open																																					
Physical layer and addresses	Factory settings RS 485 / address: 1																																				
Baudrate	9600																																				
KNX																																					
Type	Factory settings TP1 (2-Draht twisted pair), certified according to KNX standard 2.1																																				
Max. power consumption	10mA																																				
Baud rate	9600																																				
2 analogue outputs																																					
Output signal	4...20 mA or 0...20 mA																																				
Supply voltage	6...24 VDC																																				
Electrical isolation	max. 48 VDC																																				
Maximum resistance	≤ 837 ohms at 24 VDC, 0 ohms at 6 V																																				
Maximum transformer error	0.15% of measured value + 0.15% of end value																																				
LoRa																																					
Type	LoRa WAN																																				
Regional Parameter set	EU868_14dBm																																				
Application type	OTAA or ABP																																				
Interval of emission	1 to 120 min with 1min resolution																																				
Data contents	7 different predefined contents																																				
Antenna Connector	External SMA Connector																																				