

→ Series DiTemp

→ Series SolarTemp



Including products with:



DIGITAL THERMOMETERS



A large blue graphic element in the top-left corner of the page, consisting of a rounded rectangle with a diagonal cutout on its right side.

Without external power supply

The SolarTemp and DiTemp series offers remarkable features and performance characteristics for local indication of temperature. Consistent accuracy and freedom from maintenance for the entire lifespan of the product is thus combined in one instrument.

The extremely low energy consumption of electronic digital thermometers from SIKA makes them a completely new kind of instrument. The DiTemp has a lithium battery as energy source that has a service life of around 10 years.

The SolarTemp uses a solar cell integrated into the display module as energy source and the instrument works reliably in artificial light levels of 50 lux or more. Since the statutory minimum light level for industrial operations is 100 lux, the SIKA SolarTemp can be used practically anywhere.

Wearfree and environmentally compatible

Mechanical thermometers for local indication of temperature are already available for the industrial sector. But although they manage without an external power supply, they have only an analogue display. These are filled with mercury or gas or supplied in the form of bimetal dial thermometers.

These instruments function without measuring liquids such as mercury, which also poses a risk to the health, so potential environmental pollution is effectively removed both during production and at disposal.

Remote-working thermometers are also available. These are considerably easier to install since routing a flexible electrical cable presents few problems compared to a rigid capillary tube. The sensor is connected to the display unit by a plug connector. A front pane of hardened glass with FDA approval is available for food applications.

Advantages

- No maintenance whatsoever required over the lifespan of the product through the use of a photovoltaic cell for artificial light from 50 lux or a lithium battery with a service life of approx. 10 years
- Because these instruments do not have a mechanical measuring mechanism, they are extremely vibration-proof and wear-free
- Optionally available with analogue output or freely programmable switching contacts
- The integrated transducer saves space as well as acquisition and installation costs
- Easy to read display, both analogue and digital
- Intrinsically safe to RL 94/9/EG (ATEX) for zone 1 / 21



Electronic and accurate - digital and analogue

The measuring principle

Digital thermometers of the DiTemp and SolarTemp series work with a discrete-time process with one measurement cycle taking 3 seconds. The user can therefore read off the current temperature even in passing. A flashing activity symbol on the display indicates correct functioning of the instrument during the measurement cycle.

The display unit

The DiTemp and SolarTemp have an easily readable LCD display. Two different types of display are available.

The basic reasoning behind the design of the dual display unit was to give it the appearance of a traditional dial instrument. We achieved this with a circular arrangement of LCD elements. This quasi-analogue format enables you to interpret the reading as instantly as a conventional dial instrument. However, a 4-digit, 7-segment display is additionally incorporated for times when you want to know the exact temperature.



Mechanical construction

Instruments of the DiTemp and SolarTemp and have a robust mechanical assembly and are designed for both industrial applications and use in harsh environmental conditions.

For more information, see chapter „Protection tubes“.

The IP65 protection level ensures these requirements are met. The immunity to electromagnetic interference satisfies the requirements of the current industrial standards.

Continuous self-test

After switch-on, the instrument performs an internal selftest that includes a check of the connected sensor. Automatic diagnostic routines continuously monitor the sensor signal and a broken sensor is indicated via the display unit. The microprocessor constantly tests the sensor signal for plausibility. In the event of a fault, the results are indicated on the display as an error code.

Integrated measurement transducer

Integration of the measurement transducer into the local display unit means the space requirement is substantially reduced along with acquisition and installation costs, since a complete measuring point is saved. The measurement transducer system is independent of the local display unit, providing you with a redundant measuring system. The instrument is supplied via the transmitter, so there is no load on the battery or solar cell unless the current loop fails. This means the local display is both reliable and independent.

Freely programmable switching contact

The absence of mechanical contacts makes the thermometer fail-safe and prevents unwanted switching operations through vibration, for example. In addition to the programmable alarm contact, the instrument has a signalling contact that indicates all faulty operating states such as broken sensor or battery charge level. The contacts are designed as normally open contacts. Programming is performed without touching the instrument and is menu assisted. All operating states are monitored by the electronics. In contrast to mechanical instruments, the user has the benefit of a measuring system that is significantly more reliable und stable over the long term.



Series DiTemp

Type LCK for measuring ranges -40...200 °C



Technical datas	
Measuring input	Pt1000 / 2-wire
Display	Single-row , 3½ digit 7 segment LCD, 21 mm high
Resolution	0.1 °C in range -40.0...199.9 °C
Cycle time	6 s.
Accuracy	±1 % full scale ±1 digit
Case	Bajonet case Stainless steel 1.4301 with polished front frame Glass or plastic front screen Ambient temperature -20...60 °C
Degree of protection	IP65 (frontside)
Dimensions	Ø 100 mm, depth 20 mm
Power supply	Button cell, 4 years service life

Order code

Order example		9A2	42	100	1	0	0	1	0	0	0
Type											
Immersion tube routed to the rear (axial)	LCK-02	9A2									
Immersion tube 90°	LCK-03	9A3									
Immersion tube universally adjustable	LCK-07	9A7									
Display range*											
-40...200 °C			42								
Immersion tube length* l₁	Nominal length L = l₁ + 35 mm										
100 mm	135 mm			100							
160 mm	195 mm			160							
250 mm	285 mm			250							
400 mm	435 mm			400							
Connection type*											
Connection type A, plain immersion tube					1						
Connection type AK, adjustable compression fitting					9						
Thread type*											
None						0					
Connection type AKa, adjustable compression fitting (male thread)						2					
Connection type AKi, adjustable compression fitting (female thread)						3					
Connection thread*											
Without - plain immersion tube						0					
G ¹ / ₄						L					
G ¹ / ₂						2					
G ³ / ₄						3					
M20 x 1.5						7					
M27 x 2						9					
Immersion tube material*	Connection thread material*										
Stainless steel 1.4571	None							1			
Stainless steel 1.4571	Stainless steel 1.4571							3			
Immersion tube diameter											
8 mm									0		
Connecting cable*											
None										0	
Special features*											
None											0
Shatter-proof plastic front screen (FDA version)											2

* Other specifications are available on request

Type ICB for measuring ranges -40...650 °C



Technical data	
Measuring input	Pt1000 / 2-wire
Display	Single-row, 3½ digit 7 segment LCD, 21 mm high
Resolution	0.1 °C in range -40.0...199.9 °C, else 1 °C
Cycle time	3 s
Accuracy	±1 % full scale ±1 digit
Case	Bajonet case Stainless steel 1.4301 with polished front frame Glass or plastic front screen Ambient temperature -20...60 °C
Degree of protection	IP65 (frontside)
Dimensions	Ø 100 mm, depth 45 mm
Power supply	Lithium battery, 10 years service life

Options

Analog output

- 4...20 mA / 2-wire
- 15-26 VDC loop power supply
- Pre-programmed to client specifications, error signals as per NAMUR NE43
- M12 plug including suitable connection socket

Alarm output

- Freely programmable switch point and hysteresis
- 15-26 VDC power supply
- 2 x NO contacts, fail-safe mode
- Semi-conductor relay output 24 VAC / DC 100 mA
- M12 plug including suitable connection socket

Order code

Order example		9E1	48	100	1	0	0	1	0	0	0
Type											
Immersion tube routed downwards (vertical)	ICB-01	9E1									
Immersion tube routed to the rear (axial)	ICB-02	9E2									
Immersion tube universally adjustable	ICB-07	9E3									
M12 socket at bottom, with wall holder	ICB-10	9F0									
M12 socket at bottom, mounting flange at rear	ICB-20	9G0									
M12 socket at bottom, mounting flange at front	ICB-30	9H0									
Display range*											
-40...80 °C			48								
0...120 °C			12								
0...200 °C			20								
0...300 °C			30								
Immersion tube length* l₁	Nominal length L = l₁ + 35 mm										
100 mm	135 mm			100							
160 mm	195 mm			160							
250 mm	185 mm			250							
400 mm	435 mm			400							
Connection type*											
Connection type A, plain immersion tube					1						
Connection type AK, adjustable compression fitting					9						
Thread type*											
None					0						
Connection type AKa, adjustable compression fitting (male thread)					2						
Connection type AKi, adjustable compression fitting (female thread)					3						
Connection thread*											
Without - plain immersion tube						0					
G $\frac{1}{4}$						L					
G $\frac{1}{2}$						2					
G $\frac{3}{4}$						3					
M20 x 1.5						7					
M27 x 2						9					
Immersion tube material*	Connection thread material*										
Stainless steel 1.4571	None						1				
Stainless steel 1.4571	Stainless steel 1.4571						3				
Immersion tube diameter											
8 mm								0			
6 mm								1			
Connecting cable*											
None										0	
Cable length 1 m**										1	
Cable length 3 m**										3	
Cable length 5 m**										5	
Cable length 10 m**										A	
Special features*											
None											0
4-20 mA analog output (pre-programmed to display range)											3
alarm output (freely programmable in display range)											5
shatter-proof plastic front screen (FDA version)											2

* Other specifications are available on request

** ICB-10, ICB-20, ICB-30

Type DT3 for measuring ranges -40...650 °C



Technical data	
Measuring input	Pt1000 / 2-wire
Display	Single-row, 3½ digit 7 segment LCD, 14 mm high, programmable bar graph 17 divisions
Resolution	0.1 °C in range -40.0...199.9 °C, else 1 °C
Cycle time	3 s
Accuracy	±1 % full scale ±1 digit
Case	Bajonet case Stainless steel 1.4301 with polished front frame Glass or plastic front screen Ambient temperature -20...60 °C
Protection level	IP65 (frontside)
Dimensions	Ø 80 mm, depth 45 mm
Power supply	Lithium battery, 10 years service life

Options

Analog output

- 4...20 mA / 2-wire
- 15-26 VDC loop power supply
- Pre-programmed to client specifications, error signals as per NAMUR NE43
- M12 plug including suitable connection socket

Alarm output

- Freely programmable switch point and hysteresis
- 15-26 VDC power supply
- 2 x NO contacts, fail-safe mode
- Semi-conductor relay output 24 VAC / DC 100 mA
- M12 plug including suitable connection socket

Order code

Order example		961	48	100	1	0	0	1	0	0	0
Connection type											
Immersion tube routed downwards (vertical)	DT3-01	961									
Immersion tube routed to the rear (axial)	DT3-02	962									
Immersion tube universally adjustable	DT3-07	967									
M12 socket at bottom, with wall holder	DT3-10	970									
M12 socket at bottom, mounting flange at rear	DT3-20	980									
M12 socket at bottom, mounting flange at front	DT3-30	990									
Display range*											
-40...80 °C			48								
0...120 °C			12								
0...200 °C			20								
0...300 °C			30								
Immersion tube length* l₁	Nominal length L = l₁ + 35 mm										
100 mm	135 mm			100							
160 mm	195 mm			160							
250 mm	285 mm			250							
400 mm	435 mm			400							
Connection type*											
Connection type A, plain immersion tube					1						
Connection type AK, adjustable compression fitting					9						
Thread type*											
None					0						
Connection type AKa, adjustable compression fitting (male thread)					2						
Connection type AKi, adjustable compression fitting (female thread)					3						
Connection thread*											
Without - plain immersion tube						0					
G $\frac{1}{4}$						L					
G $\frac{1}{2}$						2					
G $\frac{3}{4}$						3					
M20 x 1.5						7					
M27 x 2						9					
Immersion tube material*	Connection thread material*										
Stainless steel 1.4571	None							1			
Stainless steel 1.4571	Stainless steel 1.4571							3			
Immersion tube diameter											
8 mm									0		
6 mm									1		
Connecting cable*											
None										0	
Cable length 1 m**										1	
Cable length 3 m**										3	
Cable length 5 m**										5	
Cable length 10 m**										A	
Special features*											
None											0
4-20 mA analog output (pre-programmed to display range)											3
Alarm output (freely programmable in display range)											5
Shatter-proof plastic front screen (FDA version)											2

* Other specifications are available on request

** DT3-10, DT3-20, DT3-30

Type 901-Ex - 930-Ex for measuring ranges -40...650 °C



Technical Data

Measuring input	Pt1000 / 2-wire
Display	Single-row, 4 digit 7 segment LCD, 11 mm high, programmable bar graph 61 divisions
Resolution	0.1 °C in range -40.0...199.9 °C, else 1 °C
Cycle time	3 s
Accuracy	±1 % full scale ±1 digit
Case	Bajonet case Stainless steel 1.4301 with polished front frame Glass or plastic front screen Ambient temperature -20...60 °C
Degree of Protection	IP65 (frontside)
Dimensions	Ø 80 mm, depth 45 mm
Power supply	Lithium battery, 10 years service life

Options

Analog output

- 4...20 mA / 2-wire
- 15-26 VDC loop power supply
- Pre-programmed to client specifications, error signals as per NAMUR NE43
- Angle plug including suitable connection socket

Alarm output

- Freely programmable switch point and hysteresis
- 15-26 VDC power supply
- 2 x NO contacts, fail-safe mode
- Semi-conductor relay output 24 VAC / DC 100 mA
- Angle plug including suitable connection socket

Order code

Order example		901	48	100	1	0	0	1	0	0	1
Type											
Immersion tube routed downwards (vertical)	901-EX	901									
Immersion tube routed to the rear (axial)	902-EX	902									
Immersion tube universally adjustable	907-EX	907									
M12 socket at bottom, with wall holder	910-EX	910									
M12 socket at bottom, mounting flange at rear	920-EX	920									
M12 socket at bottom, mounting flange at front	930-EX	930									
Display range*											
-40...80 °C			48								
0...120 °C			12								
0...200 °C			20								
0...300 °C			30								
Immersion tube length* l₁		Nominal length L = l₁ + 35 mm									
100 mm		135 mm		100							
160 mm		195 mm		160							
250 mm		285 mm		250							
400 mm		435 mm		400							
Connection type*											
Connection type A, plain immersion tube					1						
Connection type AK, adjustable compression fitting					9						
Thread type*											
None					0						
Connection type AKa, adjustable compression fitting (male thread)					2						
Connection type AKi, adjustable compression fitting (female thread)					3						
Connection thread*											
Without - plain immersion tube						0					
G $\frac{1}{4}$						L					
G $\frac{1}{2}$						2					
G $\frac{3}{4}$						3					
M20 x 1.5						7					
M27 x 2						9					
Immersion tube material*		Connection thread material*									
Stainless steel 1.4571		None						1			
Stainless steel 1.4571		Stainless steel 1.4571						3			
Immersion tube diameter											
8 mm								0			
6 mm								1			
Connecting cable*											
None										0	
Cable length 1 m**										1	
Cable length 3 m**										3	
Cable length 5 m**										5	
Cable length 10 m**										A	
Special features*											
Hazardous area version PTB 05 ATEX 2036 Eex ia IIC T3											1
4-20 mA analog output and hazardous area version (pre-programmed to display range)											4
Alarm output and hazardous area version (freely programmable in display range)											6

* Other specifications are available on request

** 910-EX, 920-EX, 930-EX

Overview DiTemp

	Basic			Solid					
	LCK-02	LCK-03	LCK-07	ICB-01	ICB-02	ICB-07	ICB-10	ICB-20	ICB-30
Case	Bajonet case, Ø 100 mm x 20 mm			Bajonet case, Ø 100 mm x 45 mm					
Power supply	Button cell, 4 years service life			Lithium battery, 10 years service life					
LCD Display	3½ digit, 21 mm high			3½ digit, 21 mm high					
Temperature range	-40...199.9 °C			-40...199.9 °C 200...400 °C			-40...199.9 °C 200...650 °C		
Cycle time	6 s			3 s					
Accuracy	±1 % full scale			±1 % full scale			±0.2 % full scale		
Connection	Solid tube at bottom	Solid tube at bottom, 90°	Universal tube at bottom	Solid tube at bottom	Solid tube at bottom	Universal tube at bottom	M12 socket at bottom		
Mounting	Direct			Direct			Wall holder	At rear	At front
Immersion tube-Ø	8 mm			8 mm 6 mm					
Length l₁	100 mm			100 mm					
Neck tube				Ø 14 x 35 mm			Ø 25 x 35 mm		
Analogue output				✓			✓		
Alarm output				✓			✓		
Hazardous area version									

Premium												
DT3-01	DT3-02	DT3-07	DT3-10	DT3-20	DT3-30	901	902	907	910	920	930	
Bajonet case, Ø 80 mm x 45 mm						Bajonet case, Ø 80 mm x 45 mm						
Lithium battery, 10 years service life						Lithium battery, 10 years service life						
3½ digit, 14 mm high, bar graph 17 divisions						4 digit, 11 mm high, bar graph 61 divisions						
-40...199.9 °C 200...400 °C			-40...199.9 °C 200...650 °C			-40...199.9 °C 200...400 °C			-40...199.9 °C 200...650 °C			
3 s						3 s						
±1 % full scale			±0.2 % full scale			±1 % full scale			±0.2 % full scale			
Solid tube at bottom	Solid tube at bottom	Universal tube at bottom	M12 socket at bottom			Solid tube at bottom	Solid tube at bottom	Universal tube at bottom	M12 socket at bottom			
Direct			Wall holder	At rear	At front	Direct			Wall holder	At rear	At front	
8mm 6mm						8 mm 6 mm						
100 mm						100 mm						
Ø 14 x 35 mm			Ø 25 x 35 mm			Ø 14 x 35 mm			Ø 25 x 35 mm			
✓			✓			✓			✓			
✓			✓			✓			✓			
						✓						

Series SolarTemp

Type LC for measuring ranges -40...200 °C



Technical data	
Measuring input	Pt1000 / 2-wire
Display	Single-row, 3½ digit 7 segment LCD, 21 mm high
Resolution	0.1 °C in range -40.0...199.9 °C
Cycle time	3 s
Accuracy	±1 % full scale ±1 digit
Case	Bajonet case Stainless steel 1.4301 with polished front frame Glass or plastic front screen Ambient temperature -20...60 °C
Degree of protection	IP65 (frontside)
Dimensions	Ø 100 mm, depth 20 mm
Power supply	Solar cell, 80 lux

Order code

Order example		8A2	42	100	1	0	0	1	0	0	0
Type											
Immersion tube routed to the rear (axial)	LC-02	8A2									
Immersion tube 90°	LC-03	8A3									
Immersion tube universally adjustable	LC-07	8A7									
Display range*											
-40...200 °C			42								
Immersion tube length* l₁		Nominal length L = l₁ + 35 mm									
100 mm		135 mm		100							
160 mm		195 mm		160							
250 mm		285 mm		250							
400 mm		435 mm		400							
Connection type*											
Connection type A, plain immersion tube					1						
Connection type AK, adjustable compression fitting					9						
Thread type*											
None						0					
Connection type AKa, adjustable compression fitting (male thread)						2					
Connection type AKi, adjustable compression fitting (female thread)						3					
Connection thread*											
Without - plain immersion tube							0				
G ¹ / ₄							L				
G ¹ / ₂							2				
G ³ / ₄							3				
M20 x 1.5							7				
M27 x 2							9				
Immersion tube material*		Connection thread material*									
Stainless steel 1.4571		None						1			
Stainless steel 1.4571		Stainless steel 1.4571						3			
Immersion tube diameter											
8 mm									0		
Connecting cable*											
None										0	
Special features*											
None											0
Shatter-proof plastic front screen (FDA version)											2

* Other specifications are available on request

Type IC for measuring ranges -40...650 °C



Technical data	
Measuring input	Pt1000 / 2-wire
Display	Single-row, 3½ digit 7 segment LCD, 21 mm high
Resolution	0.1 °C in range -40.0...199.9 °C, else 1 °C
Cycle time	3 s
Accuracy	±1 % full scale ±1 digit
Case	Bajonet case Stainless steel 1.4301 with polished front frame Glass or plastic front screen Ambient temperature -20...60 °C
Degree of Protection	IP65 (frontside)
Dimensions	Ø 100 mm, depth 45 mm
Power supply	Solar cell, 80 lux

Options

Analog output

- 4...20 mA / 2-wire
- 15-26 VDC loop power supply
- Pre-programmed to client specifications, error signals as per NAMUR NE43
- M12 plug including suitable connection socket

Alarm output

- Freely programmable switch point and hysteresis
- 15-26 VDC power supply
- 2 x NO contacts, fail-safe mode
- Semi-conductor relay output 24 VAC / DC 100 mA
- M12 plug including suitable connection socket

Order code

Order example		8E1	48	100	1	0	0	1	0	0	0
Type											
Immersion tube routed downwards (vertical)	IC-01	8E1									
Immersion tube routed to the rear (axial)	IC-02	8E2									
Immersion tube universally adjustable	IC-07	8E7									
M12 socket at bottom, with wall holder	IC-10	8F0									
M12 socket at bottom, mounting flange at rear	IC-20	8G0									
M12 socket at bottom, mounting flange at front	IC-30	8H0									
Display range*											
-40...80 °C			48								
0...120 °C			12								
0...200 °C			20								
0...300 °C			30								
Immersion tube length* l₁		Nominal length L = l₁ + 35 mm									
100 mm		135 mm		100							
160 mm		195 mm		160							
250 mm		285 mm		250							
400 mm		435 mm		400							
Connection type*											
Connection type A, plain immersion tube					1						
Connection type AK, adjustable compression fitting					9						
Thread type*											
None					0						
Connection type AKa, adjustable compression fitting (male thread)					2						
Connection type AKi, adjustable compression fitting (female thread)					3						
Connection thread*											
Without - plain immersion tube						0					
G¼						L					
G½						2					
G¾						3					
M20 x 1.5						7					
M27 x 2						9					
Immersion tube material*		Connection thread material*									
Stainless steel 1.4571		None					1				
Stainless steel 1.4571		Stainless steel 1.4571					3				
Immersion tube diameter											
8 mm								0			
6 mm								1			
Connecting cable*											
None										0	
Cable length 1 m**										1	
Cable length 3 m**										3	
Cable length 5 m**										5	
Cable length 10 m**										A	
Special features*											
None											0
4-20 mA analog output (pre-programmed to display range)											3
Alarm output (freely programmable in display range)											5
Shatter-proof plastic front screen (FDA version)											2

* Other specifications are available on request

** IC-10, IC-20, IC-30

Type 850 with mounting plate for measuring ranges -40...650 °C

- Display suitable for sensor elements Pt1000
- Degree of protection: IP65 (frontside)
- Measuring range 0...650 °C
- Optional with transmitter output 4...20mA / 2-wire
- Please see chapter "Temperature sensors" for an overview of our temperature sensors.

Technical data	
Ambient temperature	-20...60 °C (case)
Case	144 mm x 144 mm, steel case blue powder-coated, aluminium mounting plate
Power supply	Solar cell, 50 lux
Digital display	Single-row, 4 digit, 7 segment display, 25 mm high
Approved by several classification societies	

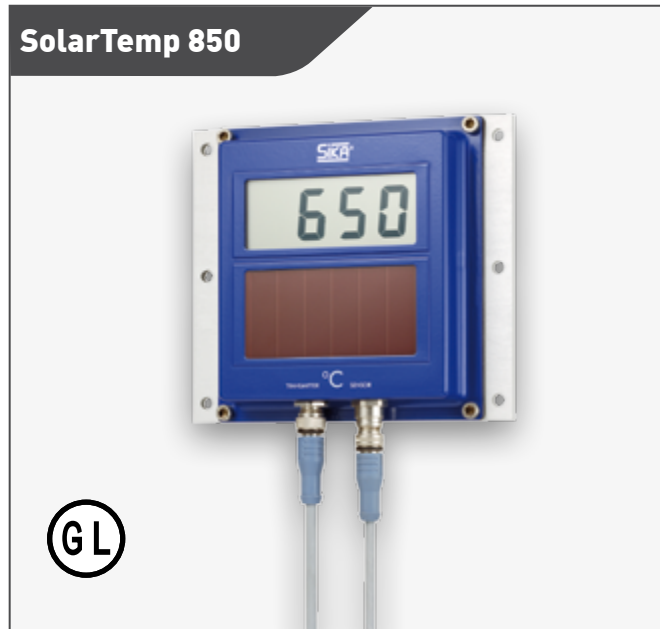

Order code				
Type	Range	SIKA-Code	ISSA-Code	IMPA-Code
Standard version	0...650 °C	85065P54	61 122 51	651861
Transmitter version	4...20 mA 0...600 °C	85065P53360	61 122 52	651862
Transmitter version	4...20 mA 0...300 °C	85065P53330	61 122 53	651863

SolarTemp applications



SolarTemp type approval certificates

- Germanischer Lloyd
- ABS
- ClassNK Nippon
- DNV
- LR
- BV
- Korean R.

Temperature sensors for SolarTemp 850

Temperature measurement in marine applications makes high demands on sensor reliability. Standard temperature sensors not specifically designed for this application will not last long time in this environment. Especially sensors used on diesel engines and propulsion systems are subject to severe vibration with acceleration as high as 200 g in some cases as well as occasional exposure to water and oil. SIKA has longterm experience in manufacturing products for the marine industry and together with engine builders and end users has developed a wide range of temperature sensors suitable for this harsh environment.

Rugged design, vibration resistant components and reliable manufacturing give SIKA sensors a long lifetime also under difficult conditions. For quality assurance each sensor is thoroughly tested during and after production. The quality management system installed by SIKA guarantees a constant and reliable performance of the products.

Due to the high flexibility of SIKA, sensors in many common designs are available. Please see chapter "Temperature sensors" for an overview of our standard sensors. Special sensors can be manufactured on request.

Important calibration instructions

Temperature sensors may be subject to changes in accuracy during their lifetime. A periodic calibration of your temperature sensors is required to make sure that they display always a correct temperature value. We provide you with the relevant calibration tools. Please see our catalogue "Test and Calibration Instruments".

SIKA temperature sensors

- For exhaust gas temperature measurement
- For cooling water temperature measurement
- For oil temperature measurement

Approvals

- Most sensors are approved by Germanischer Lloyd
- Additional approvals on request

Temperature sensors approval certificates

- Germanischer Lloyd
- ABS
- ClassNK Nippon
- DNV
- BV
- RINA



Overview SolarTemp

	Basic			Solid		
	LC-02	LC-03	LC-07	IC-01	IC-02	IC-07
Case	Bajonet case, Ø 100 mm x 20 mm			Bajonet case, Ø 100 mm x 45 mm		
Power supply	Solar cell, 80 lux			Solar cell, 80 lux		
LCD Display	3½ digit, 21 mm high			3½ digit, 21 mm high		
Temperature range	-40...199.9 °C			-40...199.9 °C 200...400 °C		
Cycle time	3 s			3 s		
Accuracy	±1 % full scale			±1 % full scale		
Connection	Solid tube at bottom	Solid tube at bottom, 90°	Universal tube at bottom	Solid tube at bottom	Solid tube at bottom, 90°	Universal tube at bottom
Mounting	Direct			Direct		
Immersion tube-Ø	8 mm			8 mm 6 mm		
Length l₁	100 mm			100 mm		
Neck tube				Ø 14 x 35 mm		
Analogue output				✓		
Alarm output				✓		
Hazardous area version						

Solid				Premium
IC-10	IC-20	IC-30	850	
Bajonet case, Ø 100 mm x 45 mm			Molded housing, 144 mm x 144 mm, depth 30 mm	
Solar cell, 80 lux			Solar cell, 50 lux	
3½ digit, 21 mm high			4 digit, 25 mm high	
-40...199.9 °C 200...650 °C			-40...650 °C	
3 s			3 s	
±0.2 % full scale			±0.2 % full scale	
M12 socket at bottom			M12 socket at bottom	
Wall holder	At rear	At front	Wall mounting	
Ø 25 x 35 mm				
✓		✓	✓	
✓		✓		

Overview Connection types

DT3 / 901 - 930 housing, Ø80 mm x 45 mm

Solid tube at bottom

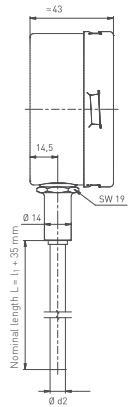

Solid tube to the rear

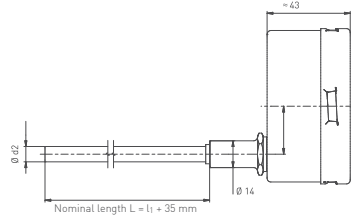

Universal adjustable tube, with optional output*

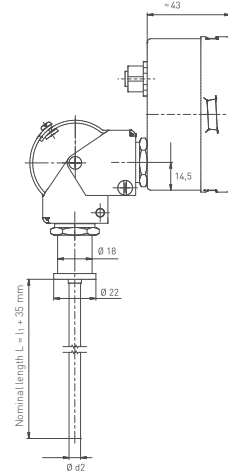

M12 socket at bottom, wall holder

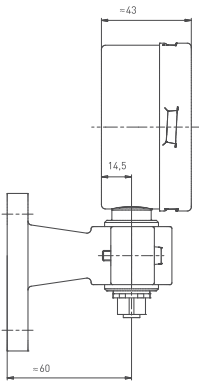

M12 socket at bottom, mounting flange at rear

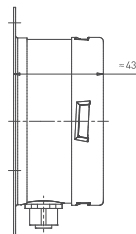

M12 socket at bottom, mounting flange at front



LCK / LC housing, Ø100 mm x 20 mm

Solid tube routed to the rear

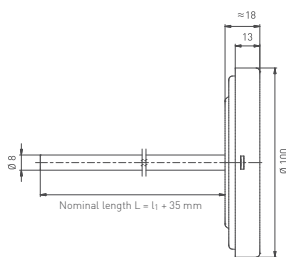

Solid tube, 90°

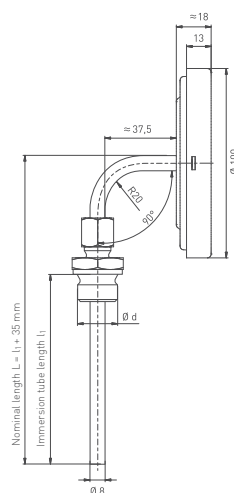

Universal adjustable tube

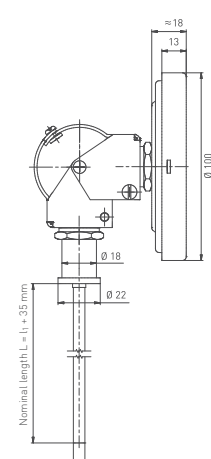

ICB / IC housing, Ø100 mm x 45 mm

Solid tube at bottom

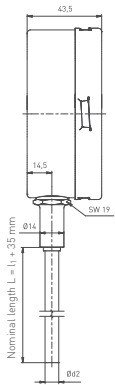

Solid tube to the rear, with optional output*

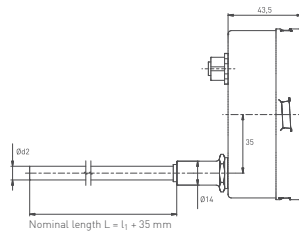

Universal adjustable tube

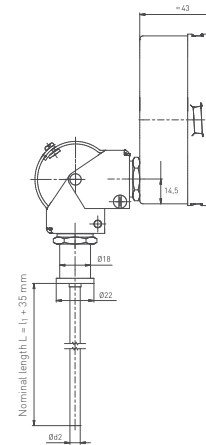

M12 socket at bottom, wall holder

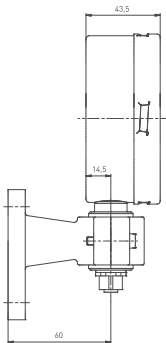

M12 socket at bottom, mounting flange at rear

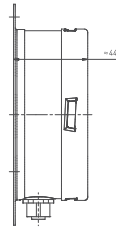

M12 socket at bottom, mounting flange at front



850 housing, 144 mm x 144 mm, depth 30 mm

Front

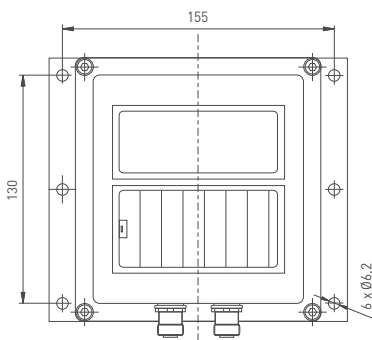

Side

